



EVERLAST CLIMBING™

A **PLAYCORE** Company





Standard Wall, Page 10



Safari Wild Web, Page 40



Ultimate Challenge Course, Page 41

CLIMBING

TRAVERSE WALLS®

River Rock® - Granite.....	8
River Rock® - Slate.....	9
Standard Wall.....	10
Magna® Wall.....	11
Relief-Feature™ Wall.....	12
Magna® Relief-Feature™ Wall.....	13
Discovery™ Blackboard Wall.....	14
Discovery™ Dry-Erase Wall.....	15
Baltic Birch™ Wall.....	16
Chroma® Traverse Wall.....	17
Superior Rock Wall™.....	18
Sandstone Relief-feature™ Wall.....	19
Mural Wall™.....	20
Adaptive Traverse Wall®.....	21
Beginner WeeKidz® Wall.....	22
WeeKidz® Traverse Wall.....	23

TOP ROPE WALL.....	24
--------------------	----

COMBINATION WALL.....	26
-----------------------	----

INSTALLATION.....	27
-------------------	----

KUMIKI CLIMBING WALLS.....	28
----------------------------	----

KUMIKI FLOORING.....	30
----------------------	----

EVERACTIVE® WALL.....	31
-----------------------	----

MATS & MAT LOCKING SYSTEMS

Mat Locking® System.....	32
Safety Mats.....	33

GROPERZ® HAND HOLDS

Traverse Wall Route-Setting Guide.....	34
Hand Hold Anatomy.....	34
Route-Setting Hand Holds.....	35
Character Holds.....	36
Alphabet & Number Holds.....	36
Adaptive Hand Holds.....	36
Critterz Hand Holds.....	36
Ball Holder.....	36

TRAINING & INSPECTION

Traverse Wall & Top Rope Wall Training.....	37
Inspection & Retraining.....	37

TEACHING TOOLS.....	38
---------------------	----

ADD-ONS & ACCESSORIES

Traverse Wall Challenge Course.....	39
Versa Challenge Course®.....	40
Ultimate™ Challenge Course.....	41

Overhang.....	42
StartFIT® Direct Mount System.....	43
Discovery Plates.....	44
Climb-Able™ Wall.....	44

TEAM BUILDING

Team-Building Resources.....	45
------------------------------	----

EARLY CHILDHOOD

WeeKidz® Challenge Course.....	46
WeeKidz® Puzzle Beams.....	46
WeeKidz® Balance Boxes.....	47

JUNGLE GYM

SAFARI® JUNGLE GYM ELEMENTS

Monkey Bars.....	48
Wild Web.....	49
Circle Steppers.....	49
Swing Steppers.....	49
Plank Walk.....	50
Retractable Elements & Mat Locking System.....	50
Safari® Ninja Circuit.....	50

FITNESS

Hijinx® Ninja Course.....	54
---------------------------	----

OUTDOOR

Playground Walls.....	56
-----------------------	----

Many of our products are protected by U.S. Patents.
See everlastclimbing.com/patents for details.

TERMS & CONDITIONS

TERMS & CONDITIONS: Types of Payment Accepted: Visa, Mastercard, Discover, American Express, Electronic Check, Check, ACH and Cash. Payment in full to be made at the time of order. Terms may be granted to organizations upon credit approval. Invoice discrepancies must be brought to our attention within 10 days. Past due accounts will be assessed a service charge of 1.5% per month or the maximum rate permitted by law, whichever is less. Discounts do not apply to past due accounts. Product is shipped via FedEx, UPS Ground Service or LTL Truck. All freight charges are paid by the buyer. Returns must be approved and will not be accepted without a Return Authorization number. Product must be in original condition. All returns are subject to a 15% restocking fee. Custom orders are not returnable or refundable. No exceptions will be made. We reserve the right to replace products with updated products at our discretion. Prices are subject to change without notice.

The product configuration and red color of the Red-Relief Line®, Traverse Wall®, Magna®, Chroma®, Mat Locking® System, WeeKidz®, Safari® Groperz®, Discovery®, River Rock®, Versa Challenge Course® StartFIT®, EverActive® and Hijinx® are Registered Trademarks of Everlast Climbing™.

WARNING: Rock climbing indoors and outdoors is an inherently dangerous sport. The activity of climbing can lead to significant personal injury, disfigurement or death. Even though one may be climbing indoors, on an artificial wall, risks still exist. Artificial holds can spin, and on rare occasions break. Individual climbers and organizations have the sole responsibility for learning and using proper climbing technique and safety practices. The purchasers and users of our products accept full and complete responsibility for any and all damages or injury which may result from the use and/or misuse of any product purchased from Everlast Climbing.

Engaging, Inspiring and Enabling Physical Activity

Climbing Walls • Youth Activity Packages • Indoor Jungle Gym • Training Team Building • Fitness • Ninja Courses • Activity Guides • Early Childhood Products

Everlast Climbing was founded in 1991, with a focus on indoor rock climbing and hand holds. Shortly thereafter, we became motivated to focus exclusively on youth climbing after consistently hearing from educators and other youth-serving professionals that climbing attracted participants who were not previously interested in physical activity. This inspired us to further expand our product line to focus on youth and to engage more children in physical activity. We are proud to have raised the standard for indoor youth climbing with our innovative and patented products.

In 2008, Everlast Climbing became a part of PlayCore, the country's leading manufacturer of play and recreation solutions. This partnership has brought us where we are today with a dynamic line of climbing walls, and related equipment, to inspire physical activity in more and more individuals.

OUR PRODUCTS

- With each product, we engage people of diverse ages, abilities, fitness levels and interests.
- Each piece is manufactured to the highest standards in safety, design and quality.
- We offer innovation with many products that are patented or patent pending.
- The tools provided help youth meet the Physical Activity Guidelines of America.
- Our products align with the National Standards and Grade-Level Outcomes for K–12 Physical Education.

OUR SUPPORT

- As a company, we consist of dedicated staff who provide excellent customer service to help you select the products best suited to your needs.
- We offer customized, on-site staff training sessions to provide the knowledge and experience necessary to implement successful programs.
- We conduct dozens of free educational outreach sessions and demonstrations at physical education conferences across the country each year.
- Our packages include curricula and activity guides to maximize the benefits and usage of our products.

OUR PASSION

- We are compelled by the dramatic increase in overweight/obese youth and the corresponding risk for cancer, cardiovascular disease, type-2 diabetes and respiratory problems.
- We value and endorse regular physical activity and recognize the positive correlation between fitness, academic achievement and emotional well-being.
- We recognize the importance of physical education and its role in helping youth develop the knowledge, skills and confidence to be physically active for a lifetime.



WHAT IS A TRAVERSE WALL®?

A **Traverse Wall** is climbed horizontally, not vertically. Panels are 8' or 10' high and are available in varying lengths. The fun and challenge is making it from one side to the other, rather than to the top. Traverse Walls do not require ropes or harnesses.

Safety features:

- Red-Relief Line® to remind climbers of designated climbing zone
- Safety mats to provide a cushioned landing surface for climbers
- Robust curriculum with safety practices, climbing technique, teaching tips and more.
- Mat Locking® System to secure the wall when it is not in use
- Rules and guidelines sign to instruct climbers of safe climbing practices

TRAVERSE WALL PACKAGE INCLUDES

Each 4' x 8' panel includes the Red-Relief Line, 20 patented Groperz® Route-Setting Hand Holds and 66 preset placement options (unless otherwise noted in the description). Please refer to the following icons to identify which features and add-ons come with each wall package:

KEY FEATURES — THEMED HOLDS & ADD-ONS — RESOURCES —



Mat Locking System

see page 32



Red-Relief Line

see page 10

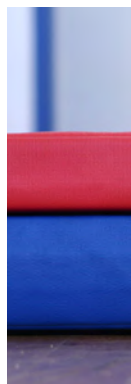

2" Standard Mat

see page 33

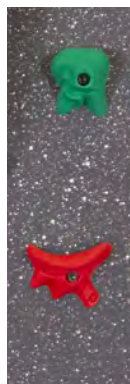

Groperz Hand Holds

see page 34



Adaptive Holds

see page 36



Groperz Critterz Holds

see page 36

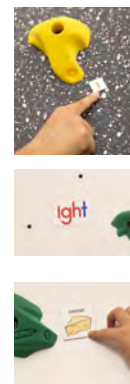

Educational Magnets

see page 14



Outlet Frames

see page 14



Activity Guide



Traverse Wall Rules & Guidelines Sign



Safety, Care and Maintenance Instructions



Link to Online Installation Video

CLIMBING | WALL OPTIONS



WHAT IS A TOP ROPE CLIMBING WALL?

A **Top Rope Wall** is a vertical climbing wall that requires a harness and safety rope that anchors at the top. This type of wall is typically 20' high and is best suited to adolescent and adult climbers since a partner (belayer) is responsible for the safety of the climber through management of the safety rope. Top Rope Climbing Walls provide vast opportunities for skill development, positive risk taking, team building and trust building. Special equipment and training are required and are included with purchase.

Safety features:

- Belay devices, rope, carabiners, harnesses and helmets
- Staff training to learn proper use of wall
- Safety mats to provide a cushioned landing surface for climbers
- Mat Locking® System to secure the wall when it is not in use
- Rules and guidelines sign to inform climbers of safe climbing practices

We proudly endorse the following organizations and initiatives:



WALL OPTIONS | CLIMBING

THE FIRST STEP IN PURCHASING A CLIMBING WALL IS DETERMINING WHAT WALL SURFACE FEATURES ARE MOST IMPORTANT TO YOU.

WALL	ROCK- REALISTIC	CROSS- CURRICULAR	SMOOTH
Standard	●		
Relief-feature	●		
Sandstone	●		
Superior	●		
Beginner WeeKidz	●		
WeeKidz	●	●	
Magna	●	●	
Magna Relief-Feature	●	●	
Discovery Dry-erase		●	●
Discovery Chalkboard		●	●
Adaptive		●	●
Chroma			●
Climb-Able			●
Baltic Birch			●
River Rock			●
Mural			●



Rock-Realistic:

Rock-like look and feel | Allows for more technical climbing | Similar to a more traditional climbing gym



Cross-Curricular:

Links activity with learning | Use with magnets or markers to integrate other subject areas
Perfect for kinesthetic learners and active schools



Smooth:

Smooth or soft surface | Sensory-friendly with an abrasion-free surface

CLIMBING | RIVER ROCK® WALL



RIVER ROCK WALL

Our River Rock Wall features a smooth surface like a polished river rock, perfect for all levels of climbing ability. 8' high walls come with 20 hand holds and 66 preset placement options per panel. A 10' high version and a Fire Retardant upgrade are available. 10' walls come with 25 hand holds and 82 preset placement options. Available in Granite or Slate color options.

Protected by U.S. Patent. everlastclimbing.com/patents



WALL SURFACE TYPE:

SMOOTH



RIVER ROCK® WALL | CLIMBING



CALL OR VISIT US AT WWW.EVERLASTCLIMBING.COM FOR PRICING & MORE INFORMATION

CLIMBING | STANDARD WALL



MANY OF OUR WALLS COME WITH OUR SIGNATURE RED-RELIEF LINE, A HELPFUL REMINDER FOR CLIMBERS TO STAY WITHIN THE DESIGNATED CLIMBING ZONE.

STANDARD WALL

A Standard Wall features a granite-like look and feel. 8' high walls come with 20 hand holds and 66 preset placement options per panel. A 10' high version and a Fire Retardant upgrade are available. 10' walls come with 25 hand holds and 82 preset placement options.

Protected by U.S. Patent. everlastclimbing.com/patents

STANDARD WALL PACKAGE INCLUDES:



WALL SURFACE TYPE:

ROCK-REALISTIC



MAGNA® WALL | CLIMBING



MAGNA WALL

It's all in the name. Place, remove and arrange magnets while climbing for a truly interactive experience. Set routes, play games and lead cross-curricular activities.

8' high walls come with 20 hand holds, over 500 magnets, and 66 preset placement options per panel. A 10' high version and a Fire Retardant upgrade are available. 10' walls come with 25 hand holds and 82 preset placement options per panel.

Protected by U.S. Patent. everlastclimbing.com/patents

MAGNA WALL PACKAGE INCLUDES:



WALL SURFACE TYPE:

CROSS CURRICULAR | **ROCK-REALISTIC**



CALL OR VISIT US AT WWW.EVERLASTCLIMBING.COM FOR PRICING & MORE INFORMATION

11

CLIMBING | RELIEF-FEATURE™ WALL



RELIEF-FEATURE WALL

Rock-like features enhance the climbing experience and add visual appeal to this Traverse Wall panel. The surface is uniquely featured with a variety of fixed rock shapes that can be used along with the hand holds to climb across the wall. Test your skills by climbing the entire length of the wall using only the unique rock features. 8' high walls come with 20 hand holds and 66 preset placement options per panel. A 10' high version and a Fire Retardant upgrade are available. 10' walls come with 25 hand holds and 82 preset placement options per panel.

Protected by U.S. Patent. everlastclimbing.com/patents

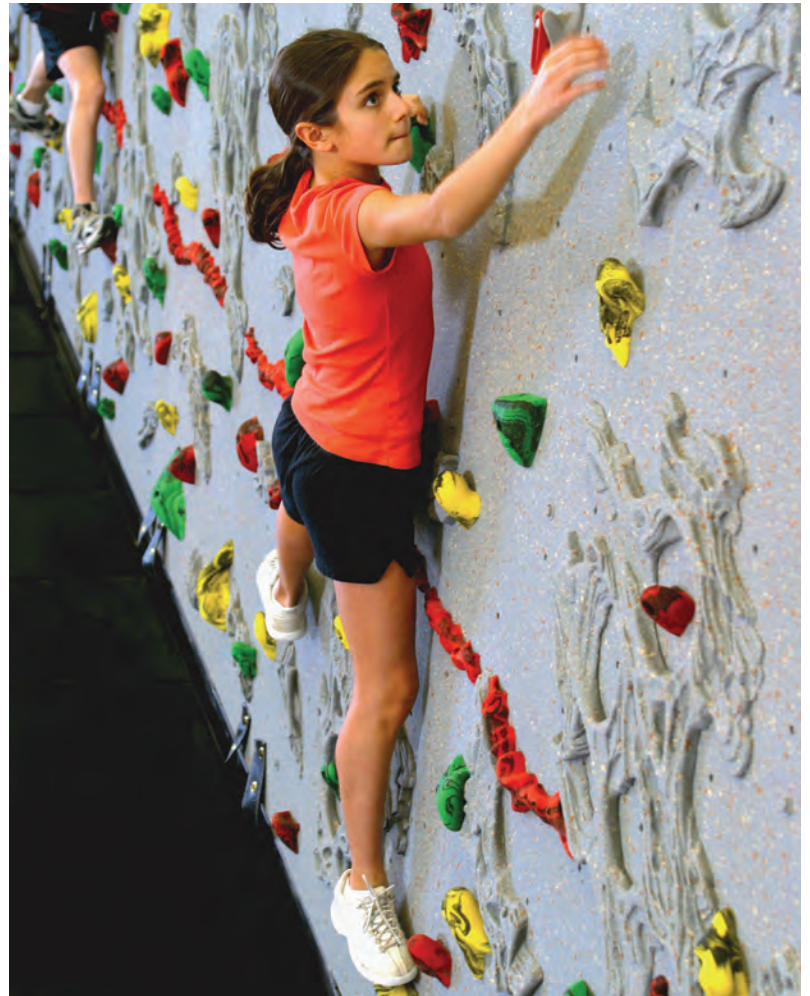

RELIEF-FEATURE WALL PACKAGE INCLUDES:



WALL SURFACE TYPE:

ROCK-REALISTIC

“

The students are so excited when they see the climbing wall mats are down – this means fun times ahead! We are already planning integration activities with our reading/math teachers and plan to expand our wall. GREAT product and GREAT service!

”

ROBERTA SIPE
Director of Wellness
Rosa Parks-Edison Elementary School - Indianapolis, IN

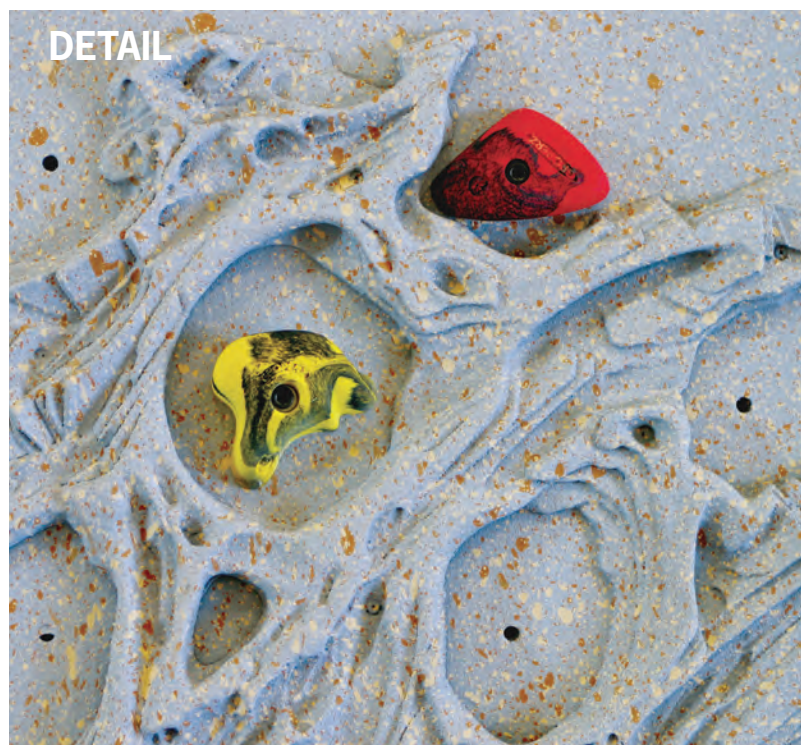

MAGNA® WALL RELIEF-FEATURE™ | CLIMBING

MAGNA RELIEF-FEATURE WALL

The great look of our Relief-Feaure panels can be enhanced with magnet-accepting capabilities. The rock-like features add climbing challenges and visual appeal, while the metallic properties enable the use of magnetic numbers and letters to engage climbers in a variety of fun and challenging cross-curricular activities. Place, remove and arrange magnets as you climb. 8' high walls come with 20 hand holds and 66 preset placement options per panel. A 10' high version and a Fire Retardant upgrade are available. 10' walls come with 25 hand holds and 82 preset placement options per panel.

Protected by U.S. Patent. everlastclimbing.com/patents

MAGNA RELIEF-FEATURE WALL PACKAGE INCLUDES:



WALL SURFACE TYPE:

CROSS CURRICULAR | **ROCK-REALISTIC**



CALL OR VISIT US AT WWW.EVERLASTCLIMBING.COM FOR PRICING & MORE INFORMATION

13

CLIMBING | DISCOVERY® BLACKBOARD WALL



USE WITH MAGNETS

DISCOVERY BLACKBOARD WALL

This climbing wall features blackboard panels that accept magnets. As children climb, they can solve math problems, write words or participate in cooperative games—using chalk or magnets! 8' high walls come with 20 hand holds and 66 preset placement options per panel.

Protected by U.S. Patent. everlastclimbing.com/patents

DISCOVERY BLACKBOARD WALL PACKAGE INCLUDES:



WALL SURFACE TYPE:

CROSS-CURRICULAR | **SMOOTH**



WRITE WITH CHALK

DISCOVERY® DRY-ERASE WALL | CLIMBING

DISCOVERY DRY-ERASE WALL

As their name indicates, the Dry-Erase Panels have a write-on/wipe-off surface that also accepts magnets. Use dry-erase markers to transform your climbing wall into a learning laboratory. 8' high walls come with 20 hand holds and 66 preset placement options per panel.

Protected by U.S. Patent. everlastclimbing.com/patents

DISCOVERY DRY-ERASE WALL PACKAGE INCLUDES:



WALL SURFACE TYPE:

CROSS-CURRICULAR | **SMOOTH**



WRITE WITH DRY-ERASE MARKERS



USE WITH MAGNETS

CALL OR VISIT US AT WWW.EVERLASTCLIMBING.COM FOR PRICING & MORE INFORMATION

15

CLIMBING | BALTIC BIRCH™ WALL



BALTIC BIRCH

Add beauty to any space with this gorgeous climbing wall made from high quality Baltic birch. 8' high walls come with 20 hand holds and 66 preset placement options per panel. A 10' high version is also available. 10' walls come with 25 hand holds and 82 preset placement options. Protected by U.S. Patent. everlastclimbing.com/patents

BALTIC BIRCH PACKAGE INCLUDES:



WALL SURFACE TYPE:

SMOOTH



CHROMA® TRAVERSE WALL® | CLIMBING



CHROMA TRAVERSE WALL

This vibrant blue Traverse Wall has a smooth, durable surface that makes it perfect for early childhood and adaptive settings. 8' high walls come with 20 hand holds and 66 preset placement options per panel. A 10' high version and a Fire Retardant upgrade are available. 10' walls come with 25 hand holds and 82 preset placement options. Protected by U.S. Patent. everlastclimbing.com/patents

CHROMA WALL PACKAGE INCLUDES:



Also available in the following colors:



WALL SURFACE TYPE:

SMOOTH

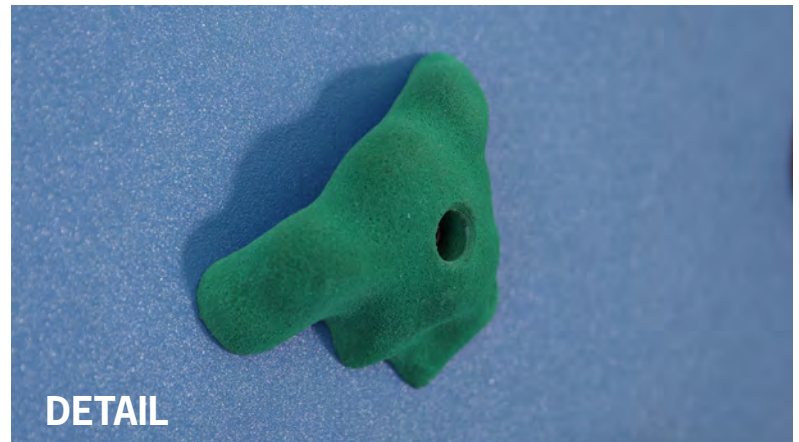

CALL OR VISIT US AT WWW.EVERLASTCLIMBING.COM FOR PRICING & MORE INFORMATION

17

CLIMBING | SUPERIOR ROCK WALL™



SUPERIOR ROCK WALL

These panels were molded from rocks along the north shore of Lake Superior. They offer an aesthetic real-rock look and feel. Each 4' x 8' section is comprised of two 4' x 4' panels and comes with 20 Groperz® Hand Holds and 50 preset placement options. Each panel exhibits unique color variations. A 10' high option is available and includes 25 holds and 70 preset placement options per section.

Protected by U.S. Patent. everlastclimbing.com/patents

SUPERIOR ROCK WALL PACKAGE INCLUDES:



WALL SURFACE TYPE:

ROCK-REALISTIC



SANDSTONE RELIEF-FEATURE™ | CLIMBING

SANDSTONE RELIEF-FEATURE WALL

Put climbing skills to the test with our Sandstone Relief-Feature Wall. Special sandstone-style hand holds are a great way to start on this wall, but try climbing on the relief features for an extra challenge. 8' high walls come with 20 hand holds and 66 preset placement options per panel. A 10' high version and a Fire Retardant upgrade are available. 10' walls come with 25 hand holds and 82 preset placement options per panel.

Protected by U.S. Patent. everlastclimbing.com/patents

SANDSTONE RELIEF-FEATURE WALL PACKAGE INCLUDES:



WALL SURFACE TYPE:

ROCK-REALISTIC



DETAIL



CALL OR VISIT US AT WWW.EVERLASTCLIMBING.COM FOR PRICING & MORE INFORMATION

19

CLIMBING | MURAL WALL



JUNGLE SCENE

MURAL WALL

Our Mural Walls bring traverse climbing to a whole new level. Our ready-to-install murals include Mountain, Forest, Ocean, Jungle and Outer Space scenes. You can also provide custom artwork and climb over mascots, logos or photography – the visual possibilities are endless! 8' high and 20' long walls come with 20 preset hand holds per panel.

Protected by U.S. Patent. everlastclimbing.com/patents

MURAL WALL PACKAGE INCLUDES:



WALL SURFACE TYPE:

SMOOTH

MOUNTAIN SCENE (20' EXTENSION ALSO AVAILABLE)



JUNGLE SCENE



OCEAN SCENE

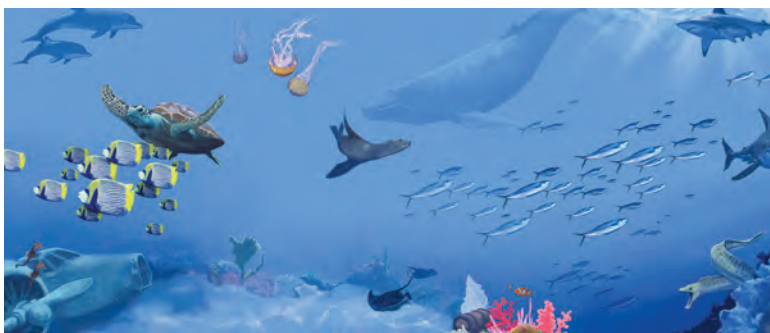

FOREST SCENE



OUTER SPACE SCENE



CUSTOM



LOOK ONLINE TO FOR MORE IMAGES OF OUR MURAL CLIMBING WALLS!

ADAPTIVE TRAVERSE WALL® | CLIMBING

ADAPTIVE TRAVERSE WALL

The Adaptive Traverse Wall, with its companion activity guide, can help instructors effectively include youth with special needs in their climbing program. The smooth, dry-erase and magnet-accepting surface can be written on. The grab-bar style hand holds and ledge-style foot holds provide stability and extra support. The Adaptive Traverse Wall is ideal for adapted or inclusive physical education, occupational therapy and physical therapy and provides opportunities to develop balance, body awareness, muscle strength, motor planning and more. Additionally, climbing provides proprioceptive input to improve sensory integration.

The Adaptive Traverse Wall is also well suited for special education classes where learning and movement can be integrated and problem solving, visual attention and concentration can be improved. 8' high walls come with 23 hand holds, 2 foot holds and 66 preset placement options per panel.

Protected by U.S. Patent. everlastclimbing.com/patents

ADAPTIVE WALL PACKAGE INCLUDES:



WALL SURFACE TYPE::

CROSS CURRICULAR | **SMOOTH**



“ I was so happy to come across your web site. I work with all children with disabilities, and you had just what I was looking for. The climbing wall is everything I wanted and more. The kids are loving it. Thank you! ”

PAULA W. DWYER
Occupational Therapist Registered
Seiter Educational Center
Greenville, MI



WATCH OUR ADAPTIVE WALL IN ACTION AT: WWW.EVERLASTCLIMBING.COM

CALL OR VISIT US AT WWW.EVERLASTCLIMBING.COM FOR PRICING & MORE INFORMATION

21

CLIMBING | BEGINNER WEEKIDZ® WALL



BEGINNER WEEKIDZ WALL

This preschool climbing wall is a beginner version of our popular Standard Traverse Wall and features grab-bar style hand holds and ledge-style foot holds to help little ones find success. Climbing on the Beginner WeeKidz Traverse Wall not only helps build gross motor skills, but also helps children develop patience, perseverance and problem-solving skills. It is 6' 10" high with hand holds placed up to 5'. Each panel includes 20 hand holds and 60 preset placement options per panel.

Protected by U.S. Patent. everlastclimbing.com/patents

BEGINNER WEEKIDZ WALL PACKAGE INCLUDES:



WALL SURFACE TYPE:

ROCK-REALISTIC



WATCH OUR WEEKIDZ WALLS IN ACTION AT: WWW.EVERLASTCLIMBING.COM

WEEKIDZ® TRAVERSE WALL® | CLIMBING



WEEKIDZ TRAVERSE WALL

Our most popular Traverse Wall is available for preschool-age children. With its Magna surface, the WeeKidz Traverse Wall not only helps build gross motor skills, but enables children to work on fine motor skills to place, remove and arrange magnets as they climb. The wall features large child-friendly holds and provides unique opportunities to reinforce learning, like letter, number and shape recognition. It is 6' 10" high with hand holds placed up to 5'. Each panel includes 20 hand holds and 60 preset placement options per panel.

Protected by U.S. Patent. everlastclimbing.com/patents

WEEKIDZ TRAVERSE WALL INCLUDES:



WALL SURFACE TYPE:

ROCK-REALISTIC | **CROSS CURRICULAR**

FOR EARLY CHILDHOOD & ELEMENTARY FREESTANDING WALLS, VISIT US ONLINE!

CALL OR VISIT US AT WWW.EVERLASTCLIMBING.COM FOR PRICING & MORE INFORMATION

23

CLIMBING | TOP ROPE WALL



TOP ROPE WALL | CLIMBING



TOP ROPE WALL

Are you looking for a more challenging climbing experience? Top Rope Walls offer climbers additional challenges and skill development beyond the Traverse Wall. Not only do Top Rope Walls build on climbers' positive risk-taking and advanced problem-solving skills, they also promote courage, communication and social skills.

Adolescent and adult climbers will thrive on the differentiated challenges featured on our Top Rope Climbing Walls. Vertical climbing facilitates the development of advanced climbing skills as well as opportunities for trust and team building.

Our Top Rope Walls can be customized to meet individual program needs. They come equipped with mats, harnesses, carabiners, helmets, rope and belay devices. Also included is an On-site Top Rope In-service. This one-day, hands-on training provides the essential knowledge and skills required to create a rewarding climbing program.



CLIMBING | COMBINATION WALL

COMBINATION WALL

Combination Walls are the best of both climbing worlds. Part Traverse Wall and part Top Rope Wall, they're ideal for organizations whose participants span a wide age spectrum.

“

Another amazing benefit of climbing is the amount of teamwork that takes place on the wall. I've been inspired by the positive encouragement my students give each other, how they work together as a team to reach their goals, and how they pat each other on the back after they achieve together.

”

TIM MCCORD

*Retired Physical Educator and Coach
Titusville ISD - Titusville, PA*

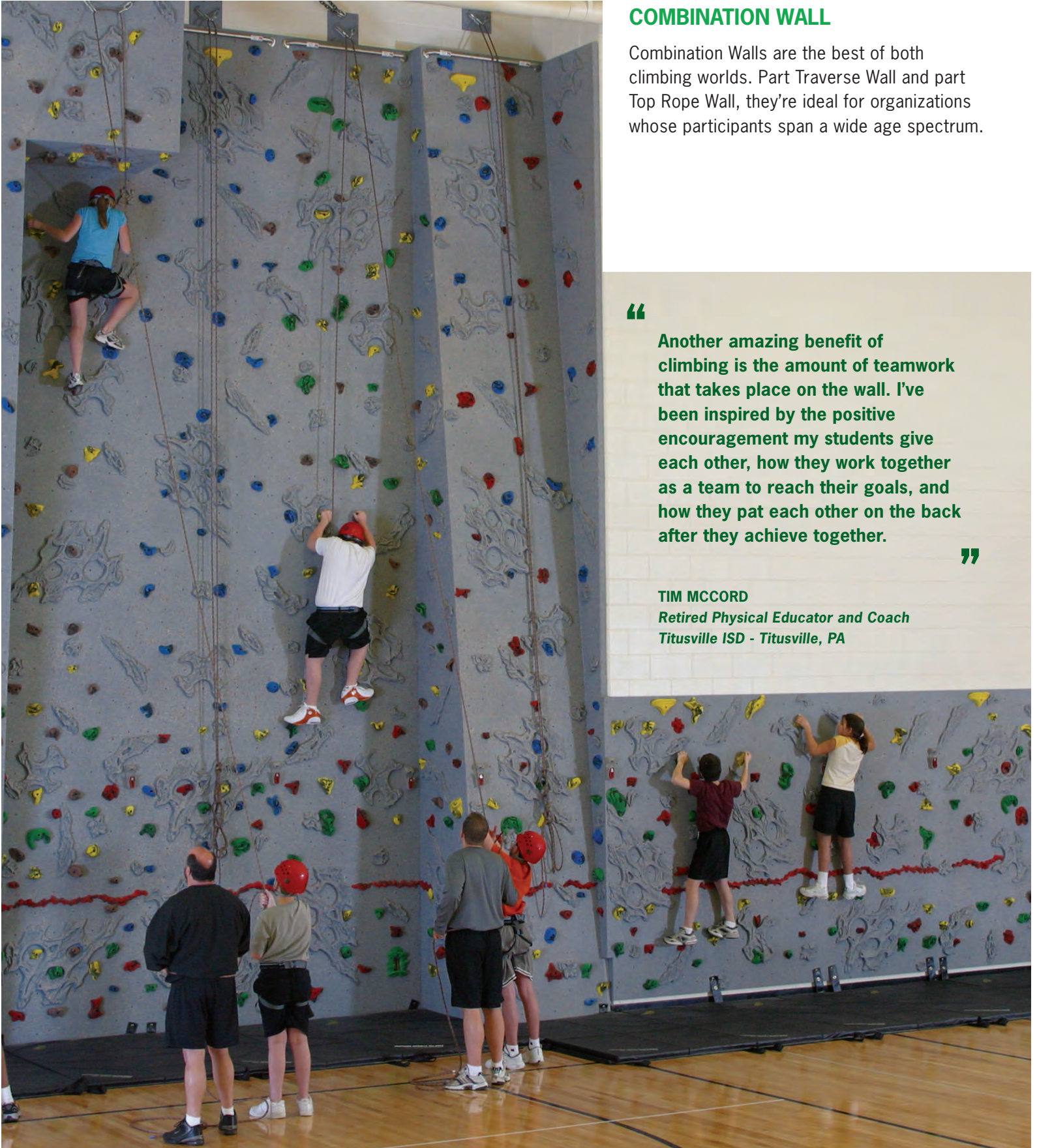

INSTALLATION | CLIMBING

PROFESSIONAL INSTALLATION

Have your equipment professionally installed! Everlast Climbing offers factory installation of Traverse Walls, Top Rope Walls and the Safari Jungle Gym. We send a team of professionally-trained installers to your site to ensure that the installation process is worry-free, efficient and completed to specifications developed by our structural engineer (if applicable). Our installation staff takes pride in its work and is covered by liability insurance. Additionally, each team member has cleared a comprehensive background check. All of our installations carry a one-year warranty.



“ Your office staff and installation crew made the creation and installation of our new climbing wall a seamless process. Our students are very excited about using it. ”

ROBERT BUCKLEY
Principal
Saugatuck Elementary School - Westport, CT

CALL OR VISIT US AT WWW.EVERLASTCLIMBING.COM FOR PRICING & MORE INFORMATION

27

KUMIKI® CLIMBING | CLIMBING WALLS

KUMIKI CLIMBING

TOP ROPE AND BOULDERING WALLS

Kumiki Climbing brings an upscale look and sophisticated climbing experience that is ideal for middle and high schools, universities and camps. Work with our designers to create a unique Top Rope or Bouldering Traverse Wall custom designed for your space and program needs. Choose from a variety of wood species, such as Baltic birch, maple, walnut, cherry, oak, ash and alder, to create a one-of-a-kind look. The patent-pending and slightly textured surface is durable and allows the natural wood grain to show through. The patent-pending steel substructure allows for easy expansion later as needs change, or budgets allow. All projects include a variety of hand holds and Kumiki Flooring (See pages 30-31).

Top Rope Walls also include harnesses, rope, belay devices and on-site training.



CLIMBING WALLS | KUMIKI® CLIMBING

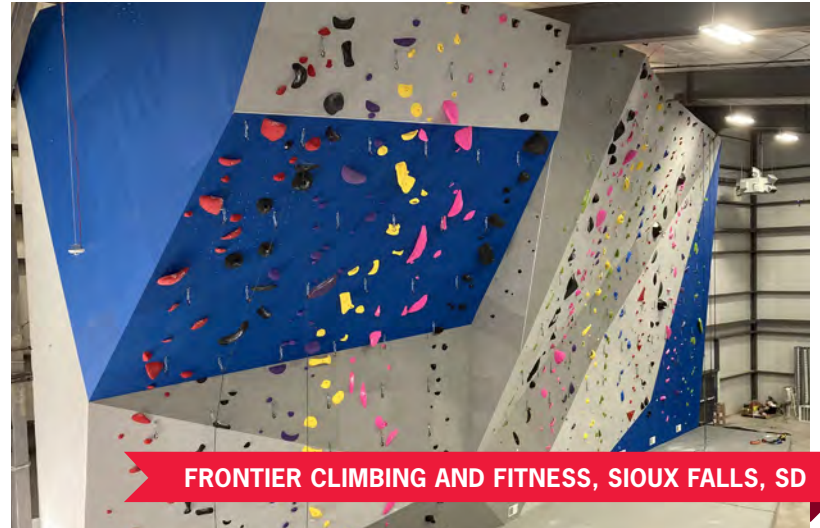

CALL OR VISIT US AT WWW.EVERLASTCLIMBING.COM FOR PRICING & MORE INFORMATION

KUMIKI® CLIMBING | FLOORING

KUMIKI CLIMBING FLOORING SYSTEMS

Kumiki Top Rope and Bouldering Traverse Walls include our custom-made Kumiki Climbing Flooring Systems to ensure an appropriate fall zone. These systems use multi-density foam layers to attenuate falls. The layers are placed over a vapor barrier and the edges of each foam piece are glued together for a uniform fall zone. Our designers will work with you to create the ideal edging and transition between floors.

Floor Covering Options:

- Carpet-bonded foam with integral hook and loop connection
- Sewn 1000 denier fabric
- Sewn vinyl
- Note: Many colors of each material are available to match your facility. Sample swatches are available.



EVERACTIVE® WALL | KUMIKI® CLIMBING

EVERACTIVE ADJUSTABLE CLIMBING WALL

Looking for a versatile training tool for your climbing program? The patented EverActive Adjustable Climbing Wall is ideal for climbers at all levels because the climbing angle is easily adjusted from 0-68° with the touch of a button. It features beautiful Baltic birch panels with a gray, black or clear coat.

Protected by U.S. Patent. everlastclimbing.com/patents

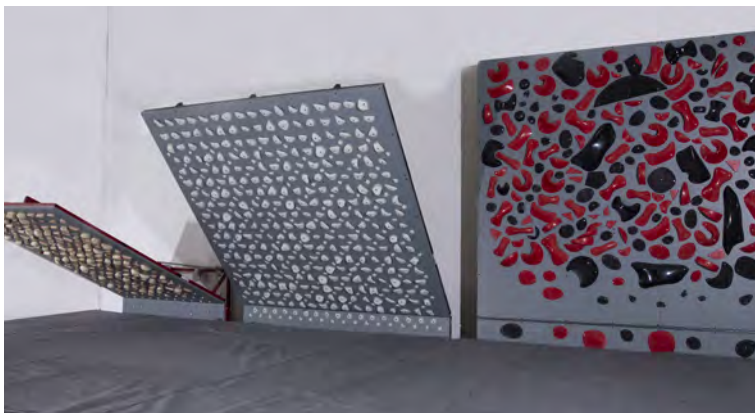

SPECS & FEATURES:

- 12' high x 8', 12' or 16' wide
- Adjustable angles (from 0-68°)
- LED lighting system to follow, create and share climbing routes (via free Kumiki Board App)
- Uses standard electric outlet
- Fast installation and easy assembly
- Freestanding version also available
- Safety surfacing sold separately



EVERACTIVE JR CLIMBING WALL

Perfect for home users, the EverActive Jr is an 8'x10' manually adjustable climbing wall. Complete your experience with matching flooring. U.S. Patent Pending

CALL OR VISIT US AT WWW.EVERLASTCLIMBING.COM FOR PRICING & MORE INFORMATION

31

CLIMBING | MAT LOCKING® SYSTEM

EASY STEPS TO LOCKING YOUR WALL

LIFT MAT • HANG LOOP • TURN AND LOCK

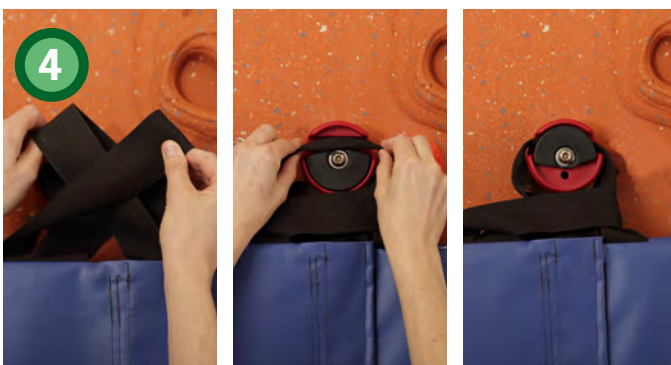

CORDLESS MAT LOCKING SYSTEM

Prevent the unauthorized use of your climbing wall with our patented Mat Locking System. This CORDLESS version is easy to use; simply hang the nylon webbing loops on the specially-designed holds, rotate the black security slider and lock with a few turns of the security bolt. The mats use a hook and loop fastening system to affix to one another and attach to the base of the wall with nylon tabs. A “No Climbing” decal is printed on the outer side to serve as notice that the wall is closed. Installation is required.

Protected by U.S. Patent. everlastclimbing.com/patents

UPGRADE WITH SIDE LOCKS

Add extra security to the Mat Locking System with our Side locks. This patented upgrade locks each end of your system and prevents someone from climbing in between the mats and the closed climbing wall. Loops on the side of each end mat attach to an additional Mat Locking Hand Hold for complete closure of your wall.

Note: Only available with purchase of a Mat Locking System.

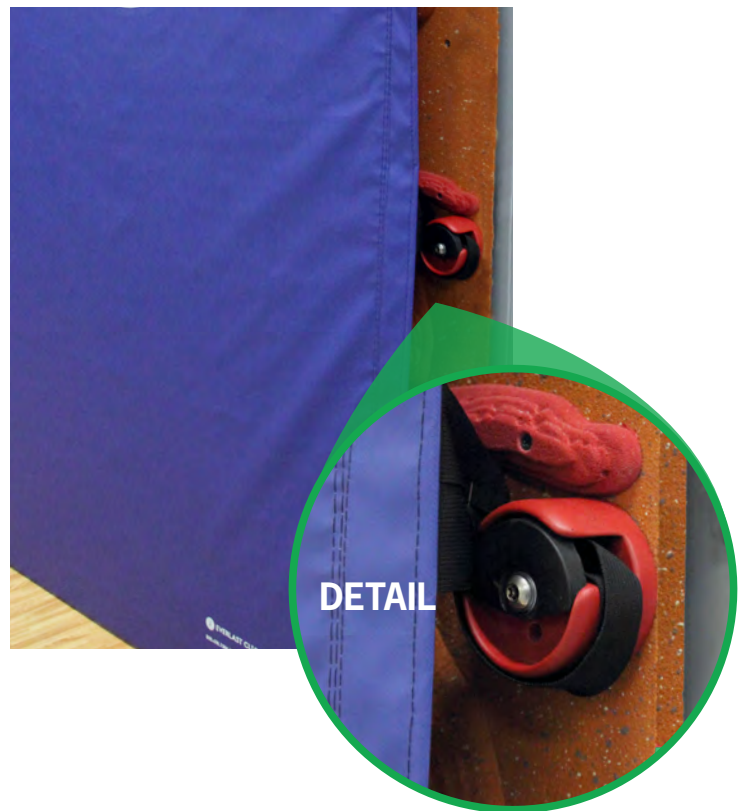

MAT LOCKING® SYSTEM | CLIMBING

We offer our Mat Locking System in three options to meet the safety requirements at your facility.

STANDARD MATS

Our Standard Mats provide fall protection safety and are ideal for facilities that do not have fire retardant requirements.

Materials: Polyethylene foam enclosed in an 18-ounce polyester-reinforced vinyl cover

STANDARDS MET	2-INCH	3-INCH
ASTM F2440-11	✓	✓
ASTM F1292-04	✓	✓

FR MATS

In addition to fall protection, our FR Mats provide fire protection safety beyond Standard Mats.

Materials: Polyethylene foam enclosed in an 18-ounce polyester-reinforced vinyl cover

STANDARDS MET	2-INCH	3-INCH
ASTM F2440-04	✓	✓
ASTM F1292-04	✓	✓
ASTM E-84 CLASS C	✓	✓

ULTRA FR MATS

Our Ultra FR Mats have our highest fire rating and also provide excellent fall protection.

Materials: Fire retardant foam enclosed in an 18-ounce polyester-reinforced vinyl cover

STANDARDS MET	2-INCH	3-INCH
ASTM F2440-04	✓	✓
ASTM F1292-04	✓	✓
NFPA 286	✓	✓

OPTIONS:

Mats are available in red and royal blue and in two thicknesses.

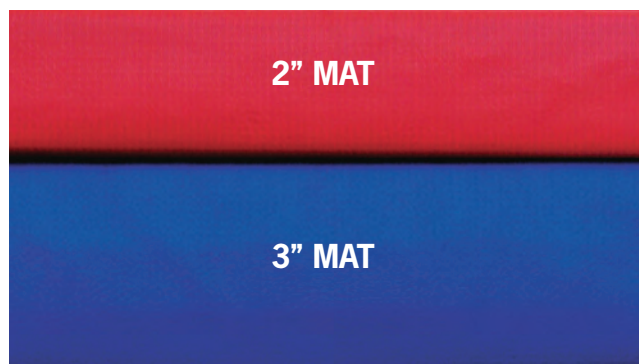

Custom colors are also available for an additional charge.



CLIMBING | GROPERZ® HAND HOLDS

BEGINNER (A–D)

LARGE SIZES
= EASY

INTERMEDIATE (E–H)

VARYING SIZES
= LIGHT CHALLENGE

ADVANCED (I–L)

MEDIUM SIZES
= CHALLENGING

EXPERIENCED (M–P)

VARYING SIZES & SHAPES
= TECHNIQUE BUILDING

GROPERZ ROUTE-SETTING HAND HOLDS

Patented Groperz Hand Holds are included with most of our climbing walls. We have a variety of shapes to offer climbers including pockets, pinches, slopers, jugs, crimps and edges. These high-quality holds are known throughout the climbing industry for their superb design and durability.

- 16 different sets available
- Color-coded to simplify level type when setting routes
- Each hold embossed with identifiers to easily set routes
- Mounting hardware and 5/16" Allen wrench included in each order
- Colors and codes are part of route maps in Route-Setting Guide (not included)

Protected by U.S. Patent. everlastclimbing.com/

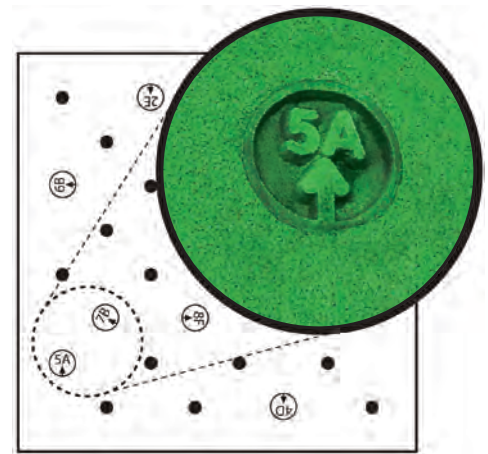

Note: Our Route-Setting Guide is not compatible with Relief Feature, Magna Relief Feature, Superior Rock, WeekKidz or Mural Walls.



TRAVERSE WALL ROUTE-SETTING GUIDE

The *Route-Setting Guide* is the only guide of its kind in the industry. The guide is intended for use with our Groperz Route-Setting Hand Holds that are labeled with numbers, letters and arrows to assist instructors with the route-setting process. Instructors can set routes of varying difficulty using the maps illustrated in this guide.

ANATOMY OF A HAND HOLD

- Specially designed for children; tendon-friendly and easy to grip.
- Hybrid resin makes holds strong and durable.
- Standardized bolt length and type make mounting and remounting holds easy.
- Hand Holds are bolted into 5/8" mechanically-fastened preset placement options (T-nuts) that are attached to the climbing wall panels with screws. Most panels come with 66 T-nuts. These preset placement options allow for moving holds and adding additional hand holds.
- Special Round Relief Texture is designed for comfort.

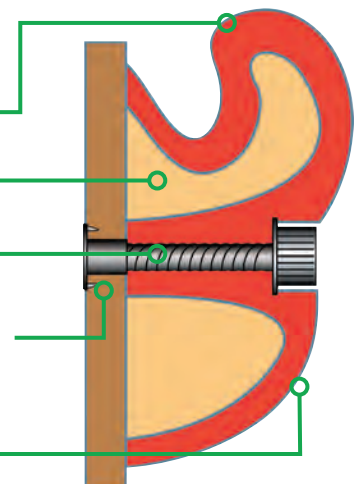

GROPERZ® HAND HOLDS | CLIMBING

GROPERZ ROUTE-SETTING HAND HOLDS (10 PER SET)

SCALE 1" 2" 3" 4" 5" 6"

BEGINNER



SET A



SET B



SET C



SET D

INTERMEDIATE



SET E



SET F



SET G



SET H

ADVANCED



SET I



SET J



SET K



SET L

EXPERIENCED



SET M



SET N



SET O



SET P

CALL OR VISIT US AT WWW.EVERLASTCLIMBING.COM FOR PRICING & MORE INFORMATION

CLIMBING | SPECIALTY HAND HOLDS

GROPERZ CHARACTER HOLDS

Reinforce character education concepts with alphabet hand holds that spell out eight character traits. Mounting hardware included.

SET 1: **CARING, RESPONSIBILITY, HONESTY, RESPECT**

SET 2: **COURAGE, DILIGENCE, KINDNESS, TRUST**



GROPERZ ALPHABET & NUMBER HOLDS

Customize your climbing wall with your organization's name, team name, words to inspire climbers or numbers to label your panels. Available in blue or red. Choose from bolt-on, which attach with preset placement options, or easy mount, which attach with wood screws. Mounting hardware included.



NOTE: Available in every letter of the alphabet and numbers 1 through 10.

GROPERZ CRITTERZ HAND HOLDS (10/SET)

Climbers will enjoy reaching for a turtle, dragonfly and other "critterz" when you add Groperz Critterz to your wall. Their bright yellow color attracts the eye and the fun shapes add variety to each panel. Available in yellow.

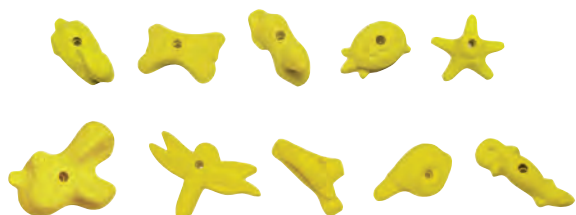

ADAPTIVE HAND HOLDS

Our specially-designed Adaptive Hand and Foot Holds provide the stability and extra support some participants need to be successful on a climbing wall. Hand holds feature a comfortable grab bar that allows for a secure grip. Hand holds can be mounted vertically, horizontally or at an angle for versatility. The Adaptive Foot Holds provide 5" deep ledges that help climbers maintain balance and lessen fatigue. They are available in two lengths.

Adaptive Hand and Foot Holds increase climbing wall accessibility for people with a variety of disabilities or mobility needs and can be mounted on most of our climbing wall panel styles.

Holds are sold in sets of one large red foot hold, one small blue foot hold and four hand holds. Mounting hardware included. *Protected by U.S. Patent. everlastclimbing.com/patents*

Note: Adaptive Hand Holds are only for use with certain Everlast Climbing Walls.



YELLOW/BLUE HAND HOLD
11" X 17"



SMALL BLUE FOOT HOLD
19" X 5"



LARGE RED FOOT HOLD
31" X 5"

BALL HOLDER

This unique hand hold was specifically designed to hold a ball during activities and initiative games and can also be used as a hand hold. Sold with five activities and mounting hardware.

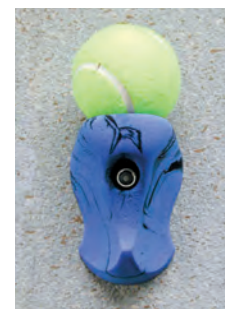

TRAINING & INSPECTION | CLIMBING

TRAVERSE WALL & TOP ROPE WALL TRAINING

Everlast Climbing provides personalized, on-site training for your staff. Our comprehensive, one-day training on Traverse Walls or Top Rope Walls is designed to provide staff with the knowledge and skills necessary to confidently teach climbing at their facility and to inspire the adoption of indoor climbing as an additional lifetime fitness activity. The hands-on training sessions are facilitated by an experienced educator and include:

- Introduction to climbing and how to include climbing in your program
- Climbing vocabulary, techniques, procedures and equipment
- Climbing activities and assessment
- Opportunities to practice climbing
- Belay technique and practice (for Top Rope Walls)
- Safety and risk management protocols
- Climbing wall and equipment maintenance

Team Building and StartFIT Fitness Trainings are also available.

Note: A Top Rope Wall Training is included with purchase of a Top Rope Climbing Wall.

INSPECTION & RETRAINING

This valuable service includes an inspection of your climbing wall with an examination of the surface features (panels, hand holds and belay anchors), as well as a review of your current risk management practices and procedures. You will receive a report of the inspection outcomes including recommendations for remediation, if applicable. Additionally, this service includes a half-day climbing wall refresher training course hosted by an educator on our staff. You may also opt for a more in-depth one-day training for staff not previously trained.

Note: This opportunity is offered only on Everlast Climbing walls.



“

The facilitator was incredibly knowledgeable and upon ending the inservice, I feel very capable teaching the climbing wall.”

JESSICA ALLRED
Health and Physical Education Teacher
Boyertown Junior High School West
Boyertown, PA

CLIMBING | TEACHING TOOLS



WE ARE PROUD TO OFFER THE MOST COMPREHENSIVE SET OF EDUCATIONAL CLIMBING MATERIALS AVAILABLE.

CLIMBING THE WALLS

This third edition includes more activities, expanded resources, color photos and a fresh new look! *Climbing the Walls* features 65 detailed lesson plans for introductory, beginner, intermediate, challenge, station and cross-curricular activities. Information about safety, climbing technique, teaching tips, assessment ideas, awards and more round out this comprehensive guide. 250 pages.



TRAVERSE WALL ASSESSMENT PACKAGE

An inspiring way to collect, document and celebrate climbers' efforts and progress during the climbing wall session. Using goal-setting, journaling, rubrics, observations, self-assessment and more, you will be able to comprehensively and objectively assess participants' physical climbing skills, as well as social, emotional and cognitive progress.



CHOOSE WELL, BE WELL

Promote awareness of proper nutrition and exercise through climbing activities. Children will learn the key components of the MyPlate food guidelines and develop an understanding of the importance of adopting healthy exercise and nutrition habits. Includes a full-color MyPlate activity board (23" x 35") with a dry-erase and magnet-accepting surface; a set of 30 food magnets; a detailed activity guide divided by grade level (1st–8th) and hardware.

Note: For use on magnet-accepting walls or with Discovery® Plates.



CLIMBING FOR CHARACTER

Link character education with the world of climbing! This unique guide supports the development of eight key character traits: Honesty, Courage, Diligence, Responsibility, Kindness and Caring, Respect, Trustworthiness and Service to Others. *Climbing for Character* contains introductory and background information on character education and cross-curricular lesson plans linking climbing and character traits for children in primary, middle and upper grades.



CLIMB ACROSS AMERICA

Learn the locations of states and capitals and unscramble facts about our great nation all while enhancing physical fitness levels. The 23" x 25" Climb Across America activity board features a colorful dry-erase and magnet-accepting map of the United States. The package also includes names and capital magnets, an activity guide and hardware.

Note: For use on magnet-accepting walls or with Discovery® Plates.

ADD-ONS & ACCESSORIES | CLIMBING



TRAVERSE WALL CHALLENGE COURSE

Our patented Traverse Wall Challenge Course offers exciting opportunities for individual and team challenges. Three sizes of foam “noodles” fit into specially-designed Groperz Hand Holds to form loops, lines and starburst obstacles for children to climb over, under, around and through. You can even place balls on your Challenge Course! Set includes: six Small Single-Noodle Holds, six Large Quintuple-Noodle Holds, six 72-inch Noodles, ten 18-inch Noodles, fourteen 12-inch Noodles, five Activity Balls, mounting hardware, 5/16” Allen wrench and five sample wall activities.

Protected by U.S. Patent. everlastclimbing.com/patents

CALL OR VISIT US AT WWW.EVERLASTCLIMBING.COM FOR PRICING & MORE INFORMATION

39

CLIMBING | ADD-ONS & ACCESSORIES

VERSA CHALLENGE COURSE®

Climbers can climb over, under, around and through plastic hoops with the Versa Challenge Course. Specialized holds with clips for plastic hoops can be positioned in any direction to create a versatile and fun climbing challenge. Each set contains specialized hand holds made to connect to a repositionable clip where you can connect plastic hoops to climb through, use as targets and more. Also includes required hardware and activity guide.

Protected by U.S. Patent. everlastclimbing.com/patents

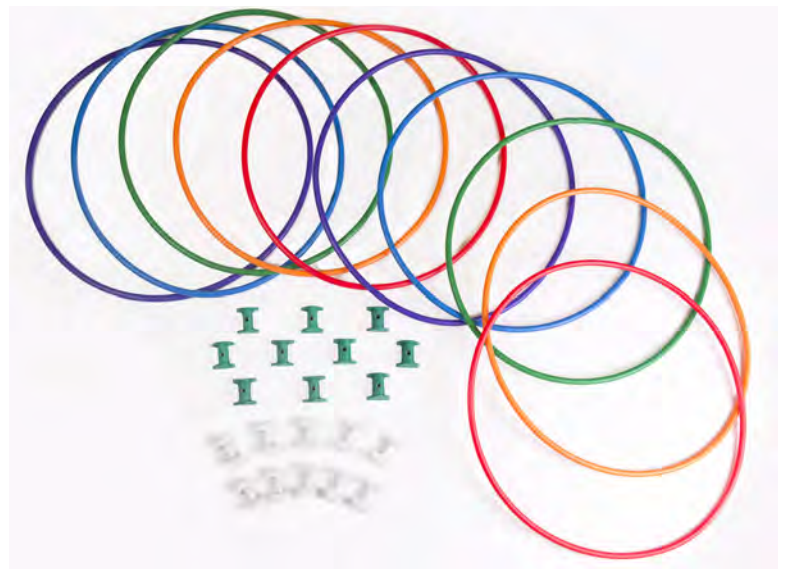

ADD-ONS & ACCESSORIES | CLIMBING



ULTIMATE CHALLENGE COURSE

Take your climbing wall to the next level with this ninja style challenge course. Three types of holds offer different challenge levels to help build upper-body strength. They can be intermixed throughout your climbing wall, used in their own sections or used along with foot holds to vary the challenge. Each set comes with 6 hook holds, 6 loop holds, 12 peg holds, 8 rings, 2 pegs, an activity guide and mounting hardware.

INCLUDES:

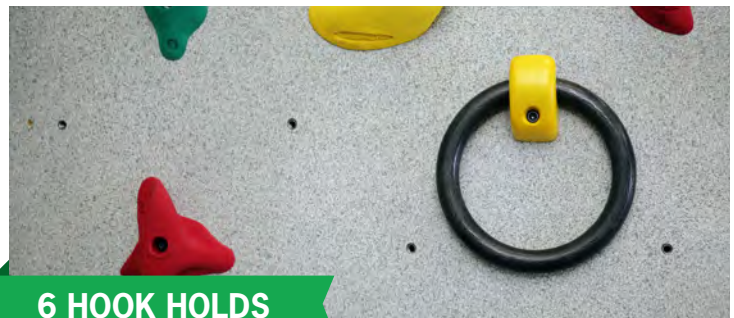

6 HOOK HOLDS



6 LOOP HOLDS

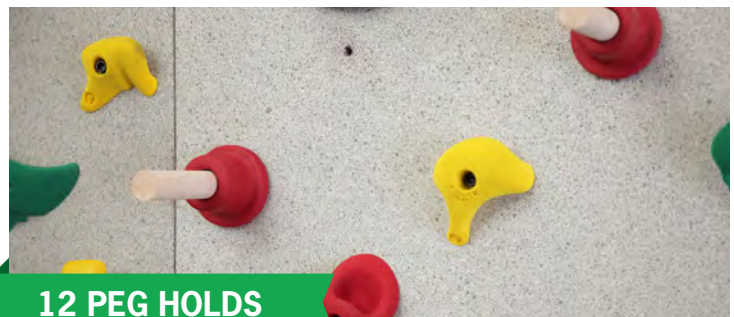

12 PEG HOLDS



ALSO AVAILABLE AS A PEG BOARD

CALL OR VISIT US AT WWW.EVERLASTCLIMBING.COM FOR PRICING & MORE INFORMATION

CLIMBING | ADD-ONS & ACCESSORIES

OVERHANG

Increase the challenge of your climbing wall with an Overhang. An Overhang can be added adjacent to your existing wall or if you are in the process of purchasing a new wall, consider adding this desirable challenge. Available in Baltic birch and built at 14° angles.



ADD-ONS & ACCESSORIES | CLIMBING

DISCOVERY® PLATES

Facilitate cross-curricular activities and games with these magnetic dry-erase plates. Instructors and participants can write on them with dry-erase markers or place magnets on them. They fit easily between the hand holds and your climbing wall. Each set of ten plates includes dry-erase markers, five activities and one set each of word, letter and math magnets.

Protected by U.S. Patent. everlastclimbing.com/patents



STARTFIT® SYSTEM

Our StartFIT System is an innovative product designed to increase the fitness-enhancing capabilities of your existing climbing wall. The StartFIT System attaches to your existing climbing wall and creates up to 11 fitness stations. The product package includes resistance tubes of varying length and strength, our detailed StartFIT Guide, individual instruction cards for each exercise station and specially-designed StartFIT Anchors to "host" each station. Available in full and small sets. Also available in Direct Mount for attaching to a CMU or brick wall.

Protected by U.S. Patent. everlastclimbing.com/patents

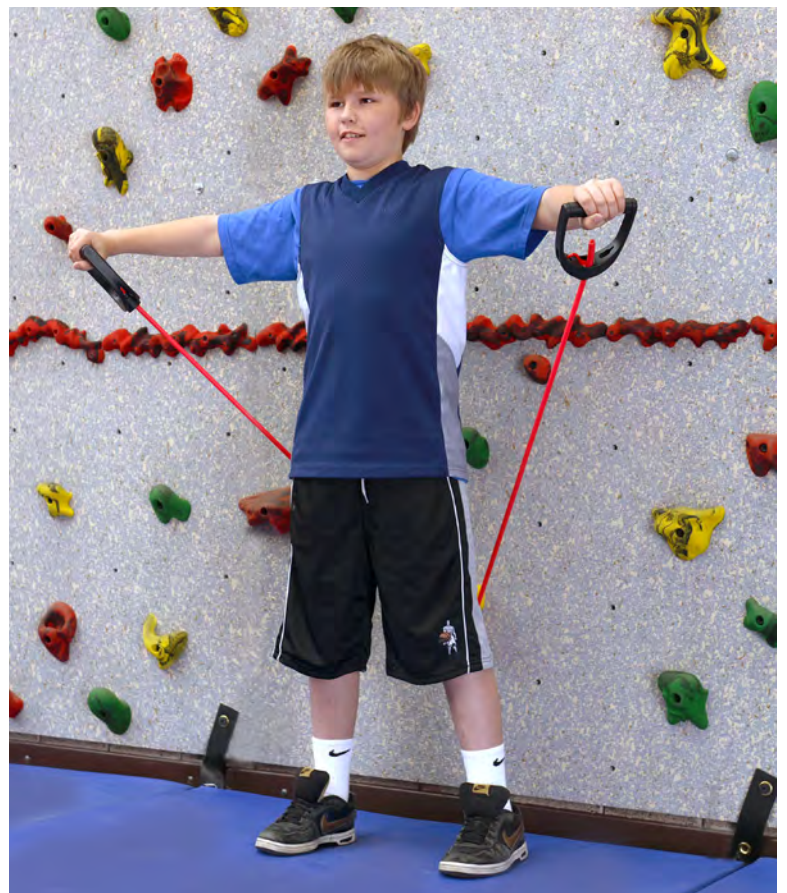

CLIMBING | ADD-ONS & ACCESSORIES



CLIMB-ABLE WALL

Great for beginners, this slab climbing wall comes with 20 easy-to-grab WeeKidz® hand holds to help climbers find success and build confidence. Made with beautiful Baltic birch, the Climb-Able wall is easy to assemble and can be mounted by itself, next to another climbing wall or in a row with several other Climb-Able Walls. It assembles and installs quickly.

Protected by U.S. Patent. everlastclimbing.com/patents

CLIMB-ABLE WALL PACKAGE INCLUDES:



WALL SURFACE TYPE:

SMOOTH



TEAM BUILDING RESOURCES | TEAM BUILDING

TEAM BUILDING RESOURCES

Team building resources are a great complement to any climbing program. They're fun and foster cooperation, communication, problem solving and more. We offer our version of classic team challenges, along with some innovative, new challenges.



ALL ABOARD

The group will learn to work together as they move from platform to platform, relying on communication, problem solving and cooperation skills. Solid wood platforms nest together for easy storage and the bases are designed to protect floors. Includes three platforms (26" x 26", 20" x 20" and 14" x 14") and activity guide.



MEMORY MAZE

Visual memory, cooperation, concentration and problem solving are required in this team challenge. The group must work together to uncover the invisible path. Square by square, they move through the grid from start to finish, starting over each time an incorrect square is used. Set includes Memory Maze grid, card set with illustrated paths and activity guide.



TOXIC WASTE TRANSFER

Using only handles of the ropes attached to the transport basket, ten people work together to move and dump the toxic waste into the neutralizing container. Set includes transport basket with 10 detachable ropes, "toxic waste" (16 balls), "neutralizing container" (basket) and activity guide.

MORE TEAM BUILDING RESOURCES ONLINE! Visit our website to see other team-building activities: Marble Maze™, Bridge Connection™, Meteorite Mission™, Human Ladder, Spider's Web, Porthole Escape™, Don't Lose Your Marbles™, Sinking Raft™ and Dinosaur Egg Transfer™.

EARLY CHILDHOOD | WEEKIDZ®

WEEKIDZ CHALLENGE COURSE

Run, hop, crawl, jump and wiggle your way through a variety of fun obstacles on the WeeKidz Challenge Course. From hurdles to agility ladders and arches, the many parts and pieces make the possibilities endless. You can even create courses for use with scooters. WeeKidz Challenge Course set includes: 20 red bases, 10 long noodles, 8 medium noodles, 11 small noodles, 3 balance beams, 6 rings, 50 - 4" connectors, 6 L-connectors, 5 T-connectors, 6 curved rubber directional arrows, 4 straight rubber directional arrows and activity guide.



WARNING: CHOKING HAZARD

This product contains small parts. Not for children under 3 years.

WEEKIDZ PUZZLE BEAMS

Develop the body and mind with balance beams that link together with unique puzzle connectors. Children will call upon their creativity and have a blast designing a variety of interesting shapes to walk across. The beams offer children the opportunity to develop balance and coordination, while the puzzle feature helps children solve problems and develop persistence, hand-eye coordination, reasoning and fine motor skills. Activity guide included.



WATCH THE VIDEOS AT: EVERLASTCLIMBING.COM



WEEKIDZ BALANCE BEAMS

Our lightweight beams offer a fun, balancing challenge with numbers, letters and shapes. Designed with young children in mind, our beams are constructed of 3-inch foam enclosed in an 18 oz. vinyl shell. Each beam has Velcro® on its end to easily attach multiple beams.

Each beam is 72"L x 4"W x 3"H. Beams are available in Alphabet, Food Groups, Numbers, Shapes, French Numbers, Spanish Numbers and Chinese Numbers.

Activity guide included.

WEEKIDZ® BALANCE BOXES | EARLY CHILDHOOD

WEEKIDZ BALANCE BOXES

These lightweight balance boxes offer a fun balancing challenge and provide opportunities to use the boxes in other activities. Designed with young children in mind, and made of beautiful, smooth birch wood. Each box has slots to place the planks at desired height. The planks easily hook in to the boxes and boxes can be arranged in a variety of patterns to develop balance and coordination. Activity suggestions with ideas of how to use the balance boxes are included.



CALL OR VISIT US AT WWW.EVERLASTCLIMBING.COM FOR PRICING & MORE INFORMATION

47

JUNGLE GYM | SAFARI®



SAFARI JUNGLE GYM

The Safari Jungle Gym is a dynamic line of indoor adventure elements that introduce age-appropriate challenge, fun and fitness to your facility. Similar to some low-ropes course elements, the Safari Jungle Gym mounts to your facility wall and is great for physical education classes, after-school programs, camps, recreation centers and inclement weather situations. The pieces challenge a wide range of fitness levels and stow and lock to prevent unauthorized use.

Elements can be bought individually or in packages with a Mat Locking System. All elements include mounting brackets, hardware, closing tool, installation instructions, safety signage and an activity guide. Elements must be mounted to concrete blocks or poured concrete walls.

MONKEY BARS

We brought this classic play element indoors. The Safari Monkey Bars develop upper body strength and coordination. Use them to bridge space between climbing wall sections, over a doorway, above a climbing wall or on their own. Made of durable, powder-coated steel.

WILD WEB

Engage every muscle of the body to make it across the Safari Wild Web! This sturdy cargo net climber combines problem solving, fun and fitness.

CIRCLE STEPPERS

Thoughtful movement and great balance are required on the Safari Circle Steppers. Travel across all five hanging discs of this low-ropes element on feet or knees.

SWING STEPPERS

Get into the swing of it with Safari Swing Steppers. Children are required to move across a set of five swinging steps for a fun balancing challenge.

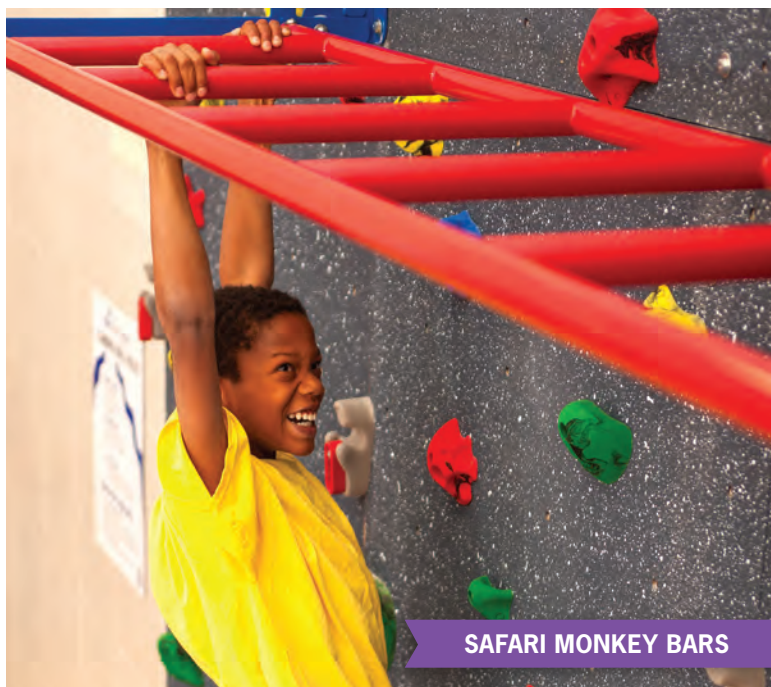

SAFARI MONKEY BARS

WATCH SAFARI JUNGLE GYM IN ACTION AT: WWW.EVERLASTCLIMBING.COM

SAFARI® | JUNGLE GYM

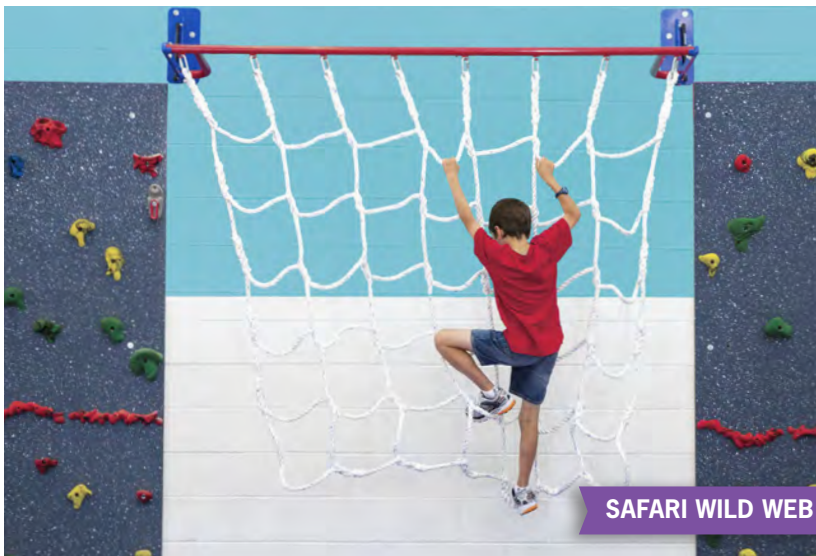

SAFARI WILD WEB



SAFARI SWING STEPPERS



SAFARI CIRCLE STEPPERS

CALL OR VISIT US AT WWW.EVERLASTCLIMBING.COM FOR PRICING & MORE INFORMATION

JUNGLE GYM | SAFARI®

EASY STEPS TO LOCKING SAFARI ELEMENTS



SAFARI PLANK WALK

PLANK WALK

Cross the Safari Plank Walk using the hanging guide ropes. It's fun and develops upper body and core strength, balance and coordination.

RETRACTABLE ELEMENTS & MAT LOCKING SYSTEM

Safari's retractable mounting brackets and Mat Locking System help prevent unauthorized use of elements. Simply push elements against the wall using the included tool and then push mats against the wall. Hang the nylon webbing loops onto the specially-designed holders, push up the red security latch and lock with a few turns of the security bolt. The mats fasten to one another and attach to the base of the wall. A "No Climbing" decal is printed on the outer side of the mats to serve as notice that Safari is closed.

Note: Circle Steppers are easily removed and stored separately prior to locking mats.



1

TIP: Use closing tool to push Safari element against the wall!

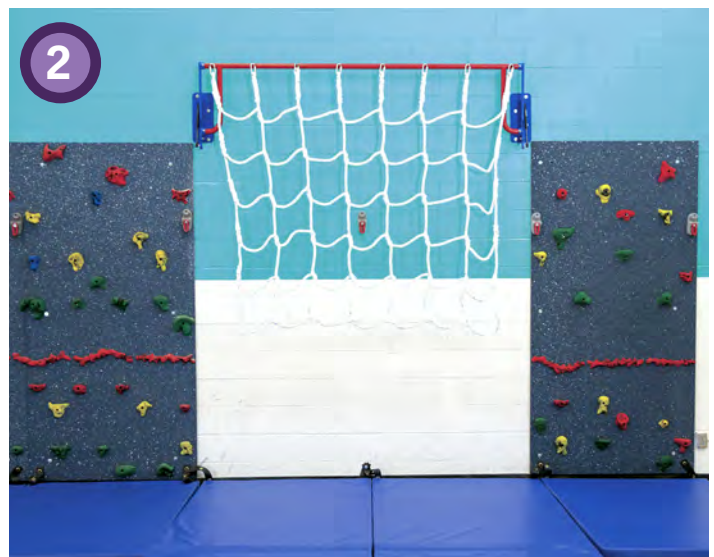

2



3

SAFARI® NINJA CIRCUIT | JUNGLE GYM

SAFARI NINJA CIRCUIT

The Safari Ninja Circuit is a great complement to our line of Safari Indoor Jungle Gym products. These circuits offer an exciting opportunity for kids of all ages to participate in the same obstacles they see on ninja obstacle course television shows. The different circuits incorporate fitness with fun and guarantee to engage and challenge kids of all ages. Comes in small, medium or large packages.



Small Package Includes:

Two Single Rings, one Triple Ring, one Double Ring and a 7' Knotted Rope with Disc.



LARGE PACKAGE

MEDIUM PACKAGE

Large Package Includes:

Four Single Rings, one Triple Ring, four 18" Knotted Ropes and one 7' Knotted Rope with Disc.

Medium Package Includes:

Two Single Rings, one Triple Ring, two 18" Knotted Ropes and one Ladder.

JUNGLE GYM | SAFARI® NINJA CIRCUIT



ELEMENTS EASILY FOLD AND LOCK TO PREVENT UNAUTHORIZED USE

HIJINX® NINJA COURSES | FITNESS



HIJINX NINJA COURSES

The Hijinx Ninja Course line guarantees to keep children of all ages engaged and having fun, while also participating in beneficial physical activity. The popularity of ninja obstacle course television shows has grown in recent years, and children will love to be able to experience a similar course for themselves. The Hijinx Ninja Obstacle Courses come in four different packages with varying supplies designed to target specific age ranges from 5 to 18.



CALL OR VISIT US AT WWW.EVERLASTCLIMBING.COM FOR PRICING & MORE INFORMATION

53

OUTDOOR | PLAYGROUND WALL



PLAYGROUND WALL | OUTDOOR



PLAYGROUND WALL

Climb the walls, even outside! Our freestanding Playground Wall allows for climbing on both sides, making it perfect for playgrounds, schoolyards or backyards. It is available in two panel styles, clear and color. Waterproof, durable and easy to clean, each panel comes with 20 Groperz Hand Holds per side and zinc-plated bolts. Panels are mounted to blue powder-coated steel posts. Walls are 12' long; make them longer with additional panel purchases. Available in two heights: 6' (for children ages 3 - 12) and 8' (for children ages 5 - 12). Required safety surfacing not included.

Protected by U.S. Patent. everlastclimbing.com/patents

WATCH THE VIDEOS AT: EVERLASTCLIMBING.COM



CALL OR VISIT US AT WWW.EVERLASTCLIMBING.COM FOR PRICING & MORE INFORMATION

55



5522 Lakeland Ave North
Minneapolis, MN 55429

651.665.9131 | 800.476.7366
WWW.EVERLASTCLIMBING.COM



© 2023 Everlast Climbing
A PlayCore Company

Top Rope Wall, Pages 24-25