

# Site Amenities

BY SUPERIOR RECREATIONAL PRODUCTS

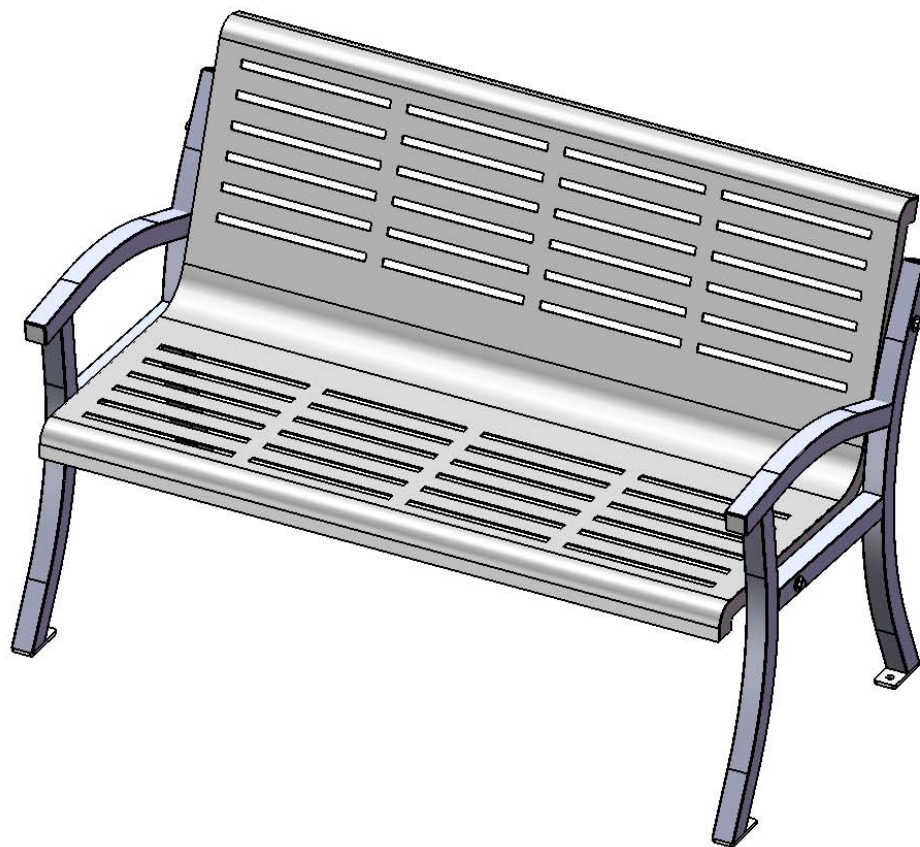

Model #  
B4WBHORZCASINO

 **SUPERIOR**<sup>®</sup>  
RECREATIONAL PRODUCTS  
A **PLAYCORE** Company

## PRODUCT SPECIFICATIONS

### **B4WBHORZCASINO 4 Ft. Casino Bench With Back**

Seats: Seat is fabricated from a 11ga laser cut plate. Seat is supported with 11ga plates. All electrically MIG welded.

Frame: Legs are cast aluminum.

Coating: Oven fused functionalized polyethylene copolymer-based thermoplastic. Fluidized bed coating application with superior mechanical performance, impact resistance and UV-stability.

Dimensions: 4' bench without back. Seats are 26-3/4" wide x 48" long. Seat height is 16-5/16". Overall dimensions are 26-3/4" x 51" x 32-3/4".

# COMPONENTS

Attach the legs to the seat as shown using specified hardware.

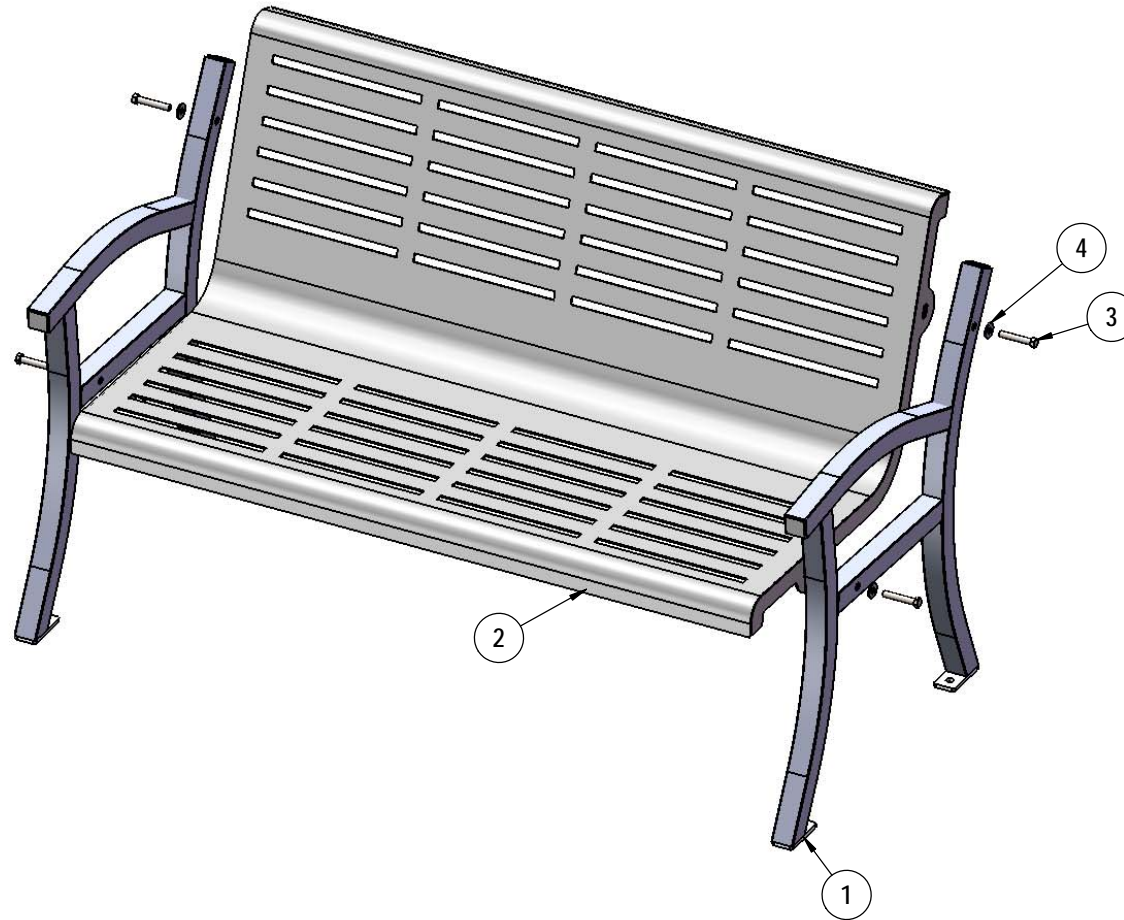

ITEM NO.	PartNo	DESCRIPTION	QTY
1	FCASINO	Frame -For- Casino Benches, Surface Mount/Portable	2
2	S4WBHORZCAS	Seat for B4WBHORZCASINO	1
3	33-05-0059	3/8" x 2 1/4" Machine Bolt (SS)	4
4	33-02-0008	3/8" Flat Washer (SS)	8
5	33-03-0013	3/8" Kep Nut (SS)	4

# OVERALL DIMENSIONS

