

Site Amenities

BY SUPERIOR RECREATIONAL PRODUCTS

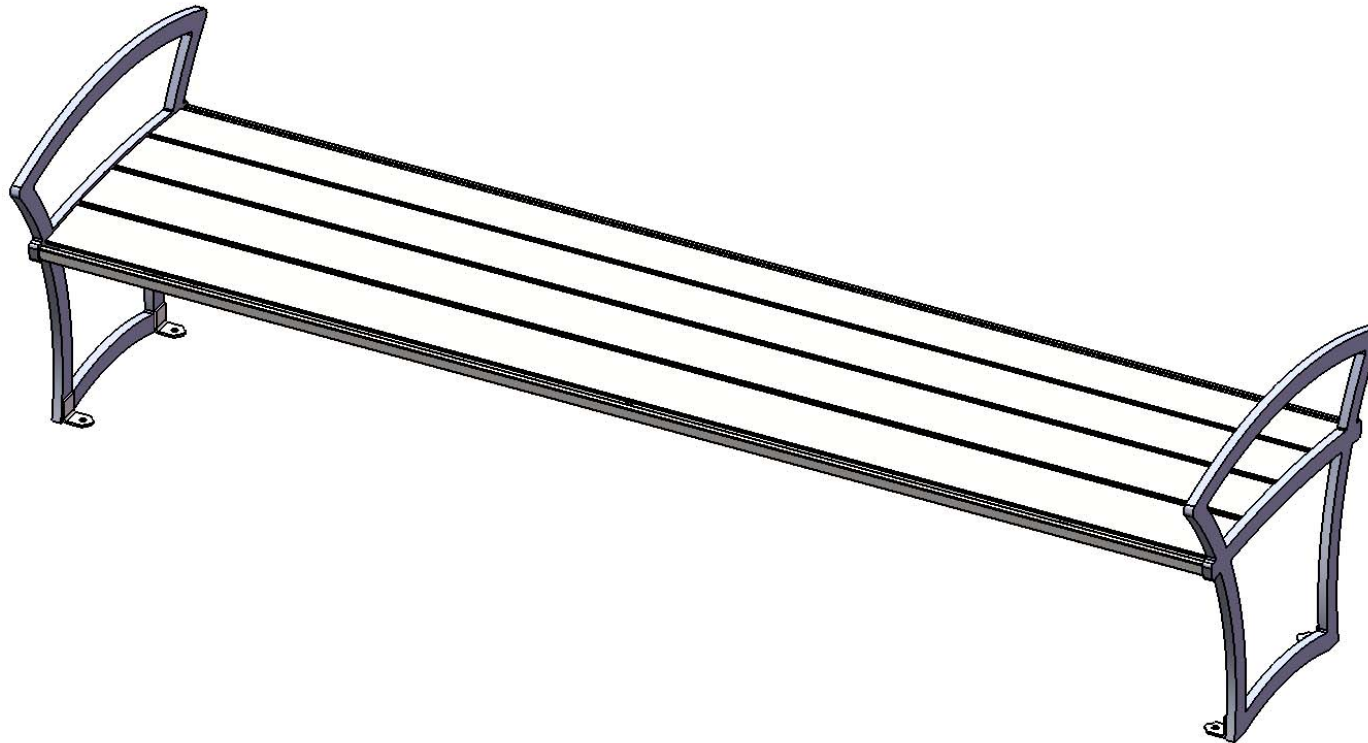

Model #
B8BY-ST-ARM

 **SUPERIOR**[®]
RECREATIONAL PRODUCTS
A **PLAYCORE** Company

PRODUCT SPECIFICATIONS

B8BY-ST-ARM BRYCE BENCH WITHOUT BACK WITH ARMREST

Seats: Seat is made from 1/4" x 5" flat steel and 1" x 1/2" solid steel bar. Reinforced with 7 gauge thick support ribs. Legs are fabricated from 3/4" steel plate. Mounting plates shall be made from 7 gauge steel. All electrically MIG welded.

Coating: Steel is sandblasted to near white condition. Coated with zinc rich epoxy primer and top coated with electrostatic powder coat, oven cured.

Dimensions: 8' portable/surface mount bench without back with armrests. Seats are 23-3/16" wide x 96" long. Seat height is 17-3/4" from the ground to the top of the seat. The overall dimensions are 96-1/2" x 29-5/16" x 26"

Recommended Surface Mount Hardware: 3/8" x 3-1/2" Concrete Expansion Anchor Bolts (Not Included)

OVERALL DIMENSIONS

