



**Structure:
FX3-NAT212-004-00**

Theme: Nature

Preliminary Concept Design

Conceptual Renderings Only. Subject to change without notice at SRP's Discretion



Transfer



Steel



Age Group

Designer: N.Guice

Date: 6/12/2023









Structure: FX3-NAT212-004-00
Age: 2-12 / Series: Steel / Theme: Nature

Preliminary Concept Design

Conceptual Renderings Only. Subject to change without notice at SRP's Discretion

- Accessible On-Route Elevated Path 
- Non-Accessible Elevated Path 
- Accessible On-Route Ground Level 
- Activities 

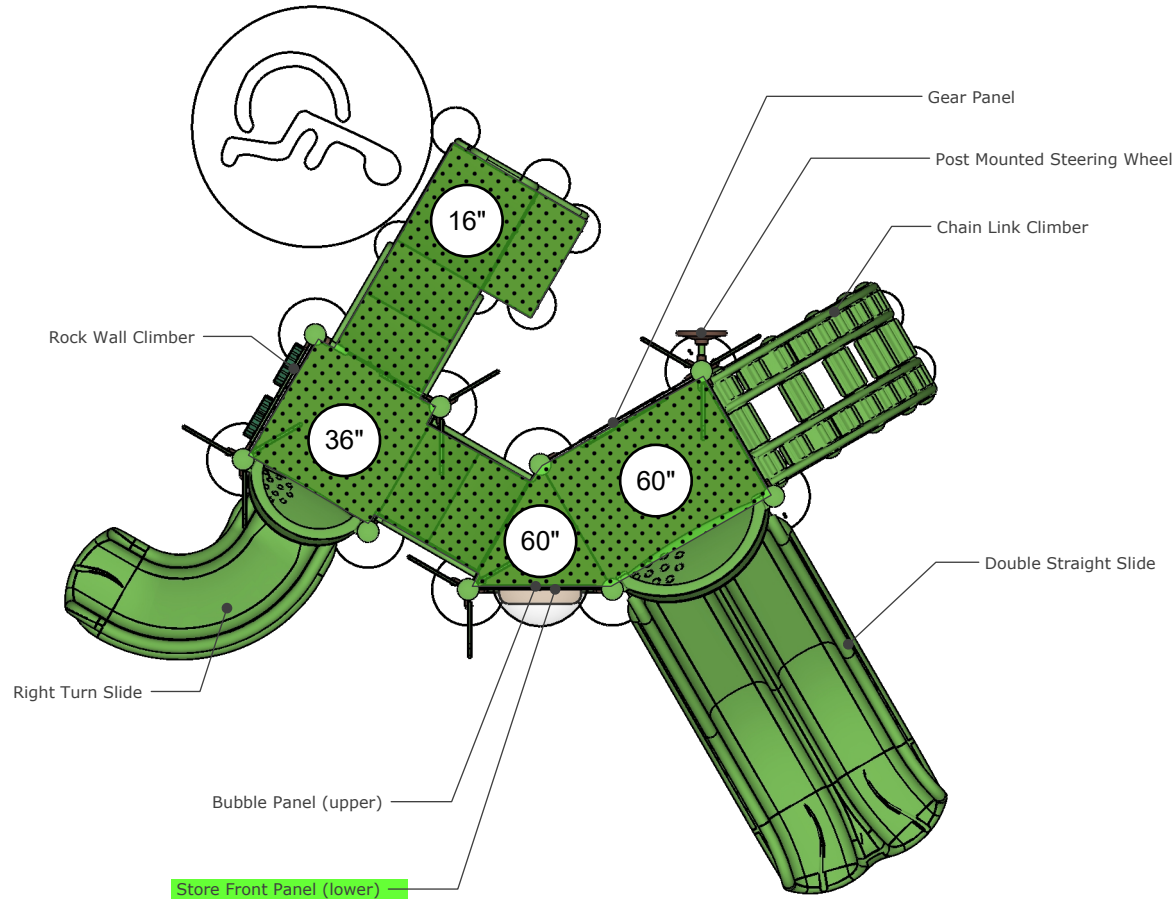

Minimal Fall Zone Surfaced with Resilient Material

Use Zone Area: 600 SqFt
Use Zone Perimeter: 96' Ft
Use Zone Dimensions: 31'x28'

Structure Size: 19'x16'
Structure Overall Height: 16'

Structure is Designed for Children Ages: 2-12

Post Diameter: 3.5" Steel

User Capacity: 27

Fall Height: 5'

48" Timber Count: 34

Designer: N Guice

Revised By:

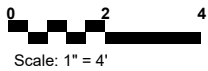

ADA Accessibility

Number of Play Events	8	
Number of Elevated Play Events	6	
Number of Elevated Play Events Accessible By Ramp	0	Required 0
Number of Elevated Play Events Accessible by Transfer System	Provided 6	Required 53
Number of Ground Level Play Events on Accessible Route	Provided 2	Required 2
Number of Types of Ground Level Play Events on Accessible Route	Provided 2	Required 2



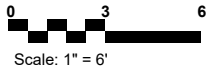
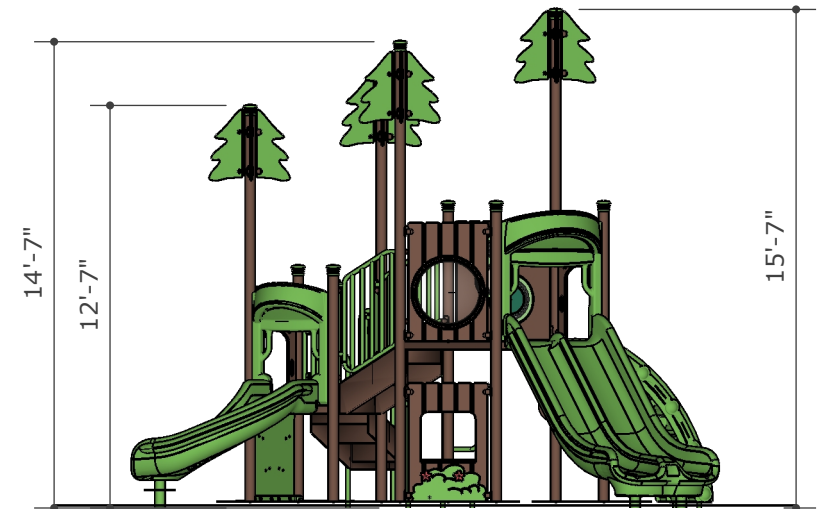
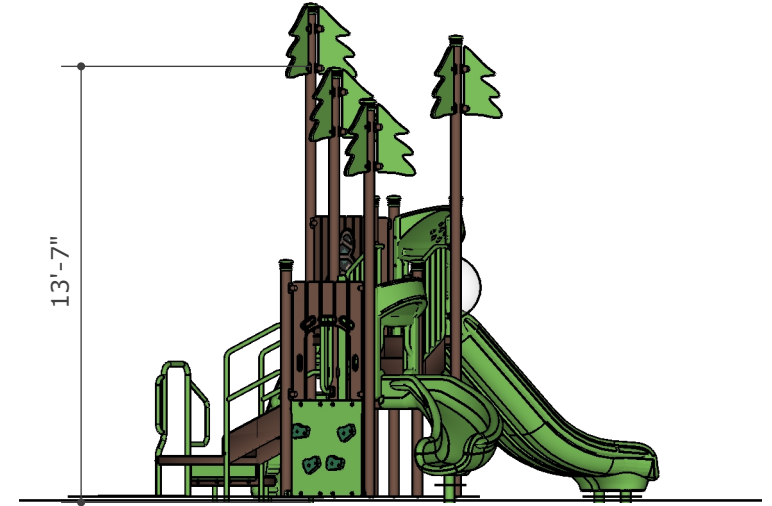
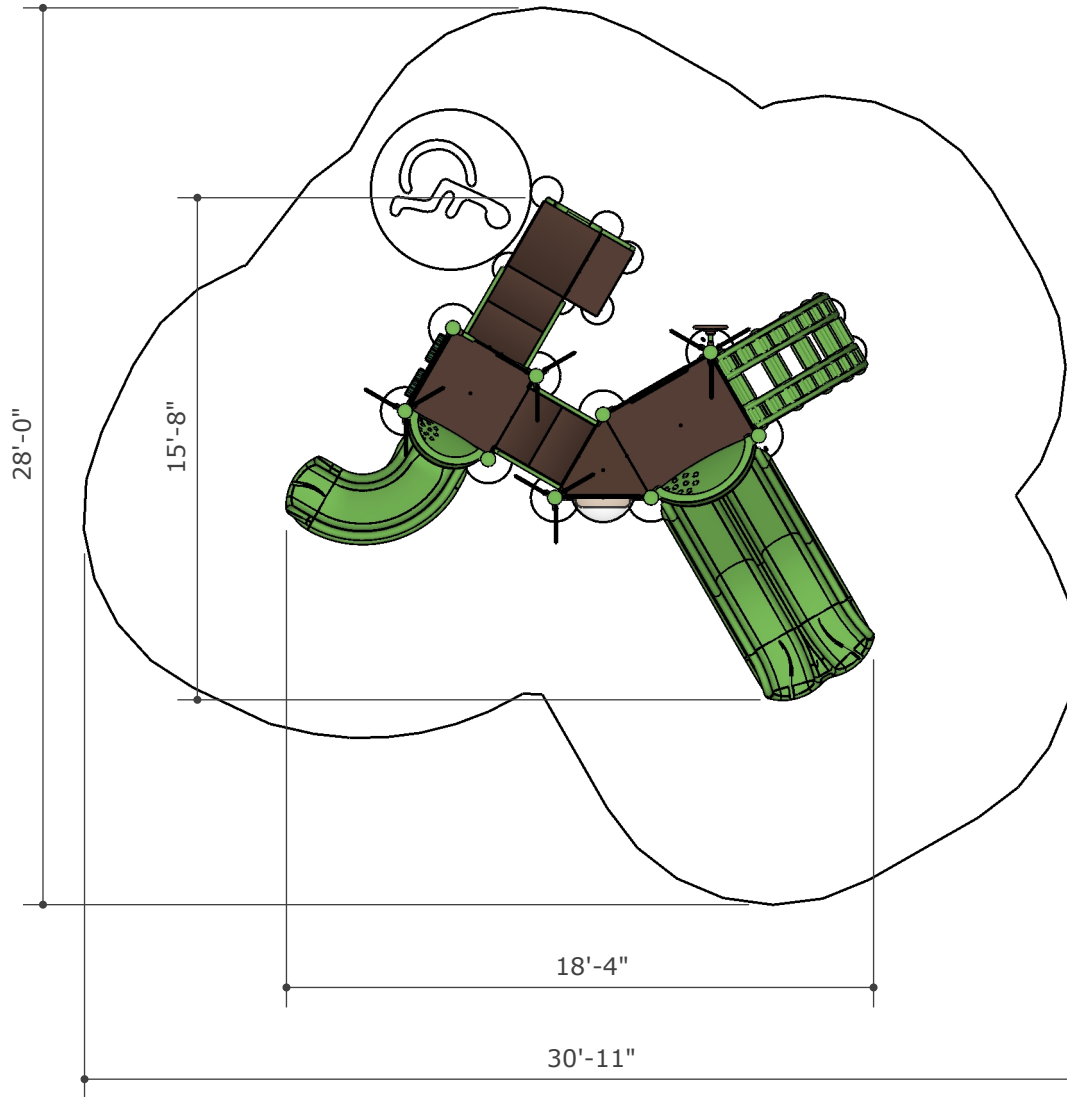

Partner

Superior[®]
RECREATIONAL PRODUCTS
A PLAYCORE Company

<https://srpplayground.com/>



srpplayground.com
866-795-7545