



**Structure:
FX3-SHP212-001-00**

**Theme:
Fishing Boat**

Preliminary Concept Design

Conceptual Renderings Only. Subject to change without notice at SRP's Discretion



Transfer



Steel



Age Group

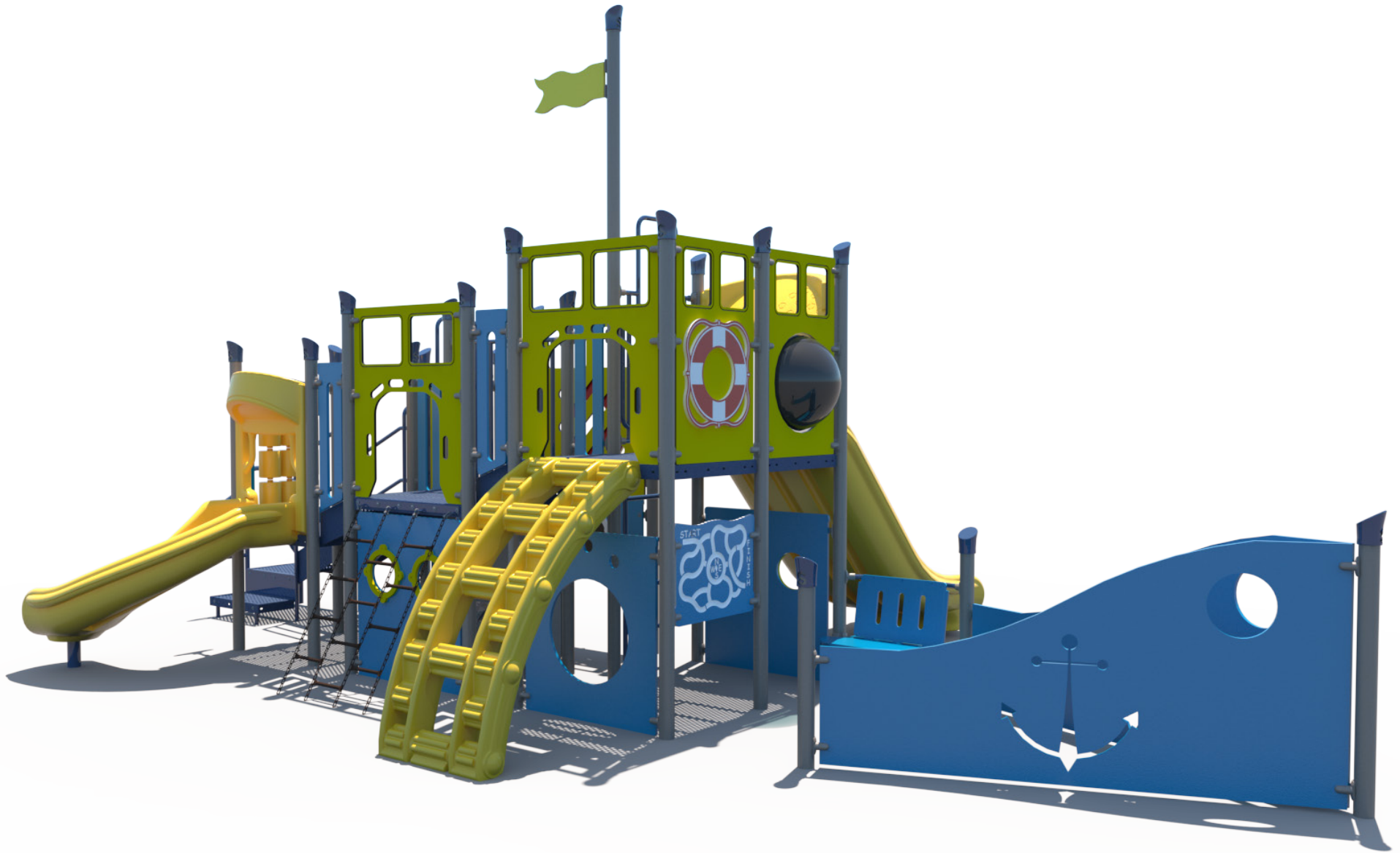

Designer: N.Guice

Date: 06/16/2023



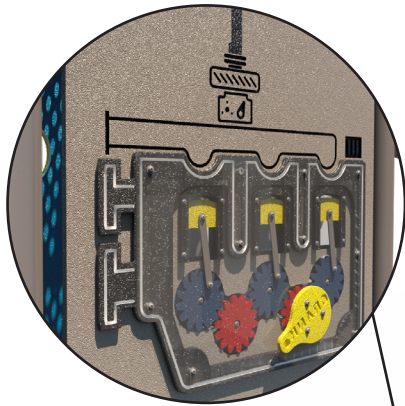



- Accessible On-Route Elevated Path 
- Non-Accessible Elevated Path 
- Accessible On-Route Ground Level Activities 

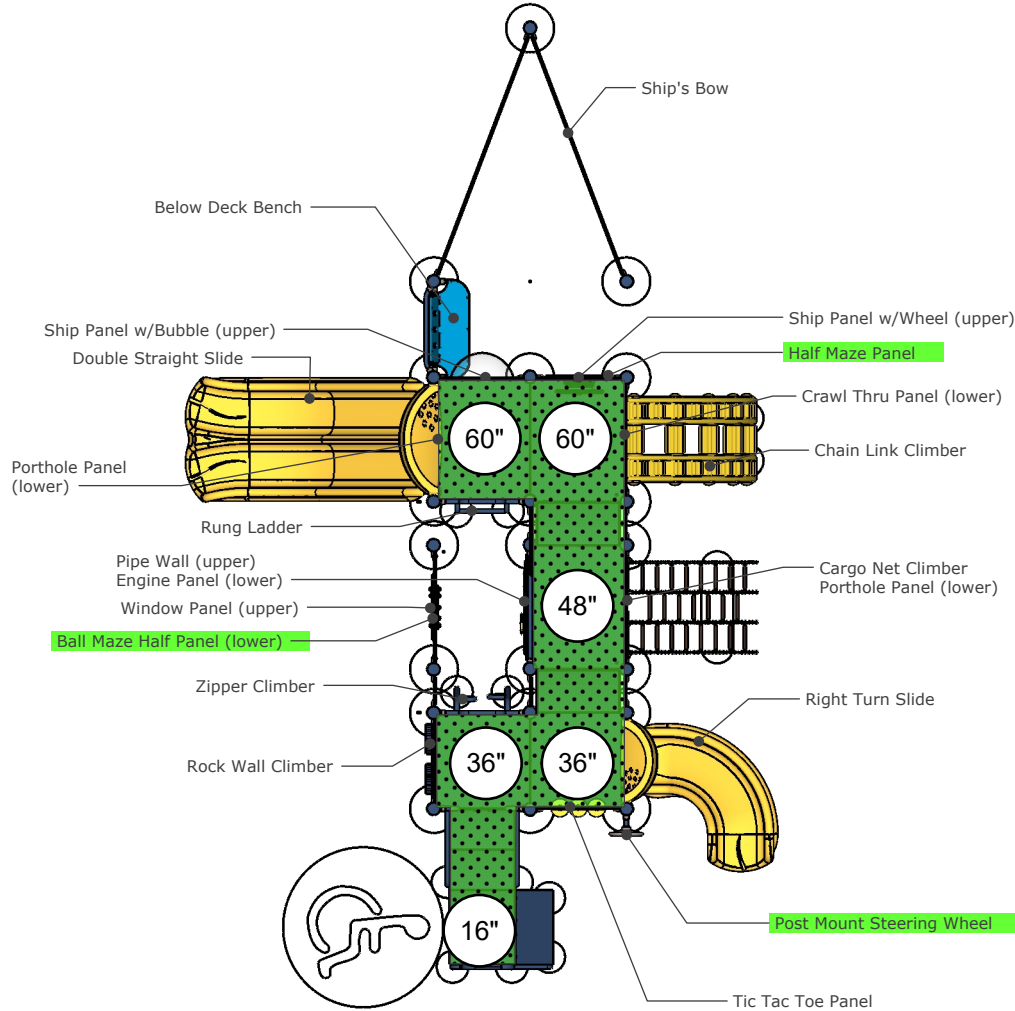

Minimal Fall Zone Surfaced with Resilient Material

Use Zone Area: 862 SqFt
Use Zone Perimeter: 120' Ft
Use Zone Dimensions: 42'x31'

Structure Size: 30'x19'
Structure Overall Height: 15'

Structure is Designed for Children Ages: 2-12

Post Diameter: 3.5" Steel

User Capacity: 45

Fall Height: 5'

48" Timber Count: 30

Designer: N Guice

Revised By:

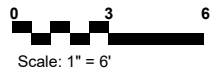

ADA Accessibility		
Number of Play Events	16	
Number of Elevated Play Events	10	
Number of Elevated Play Events Accessible By Ramp	0	Required 0
Number of Elevated Play Events Accessible by Transfer System	Provided 10	Required 5
Number of Ground Level Play Events on Accessible Route	Provided 3	Required 3
Number of Types of Ground Level Play Events on Accessible Route	Provided 3	Required 3

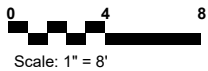
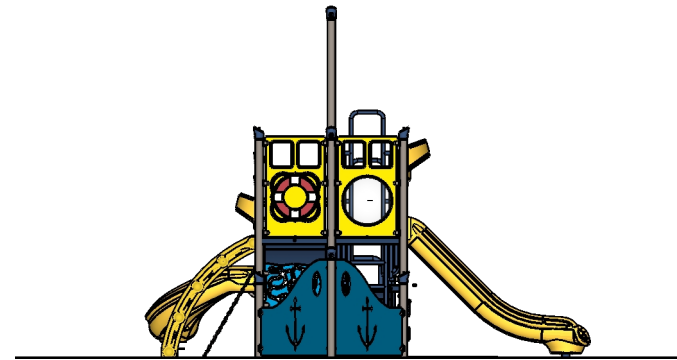
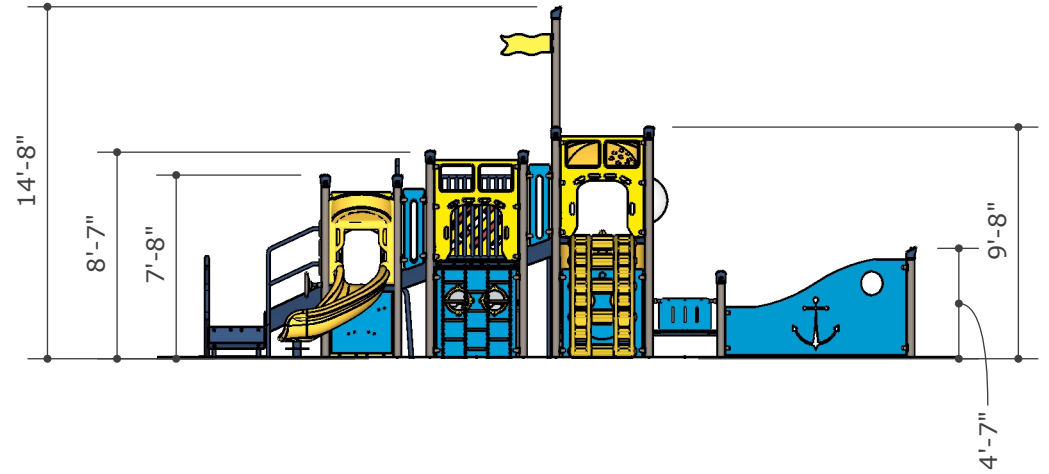
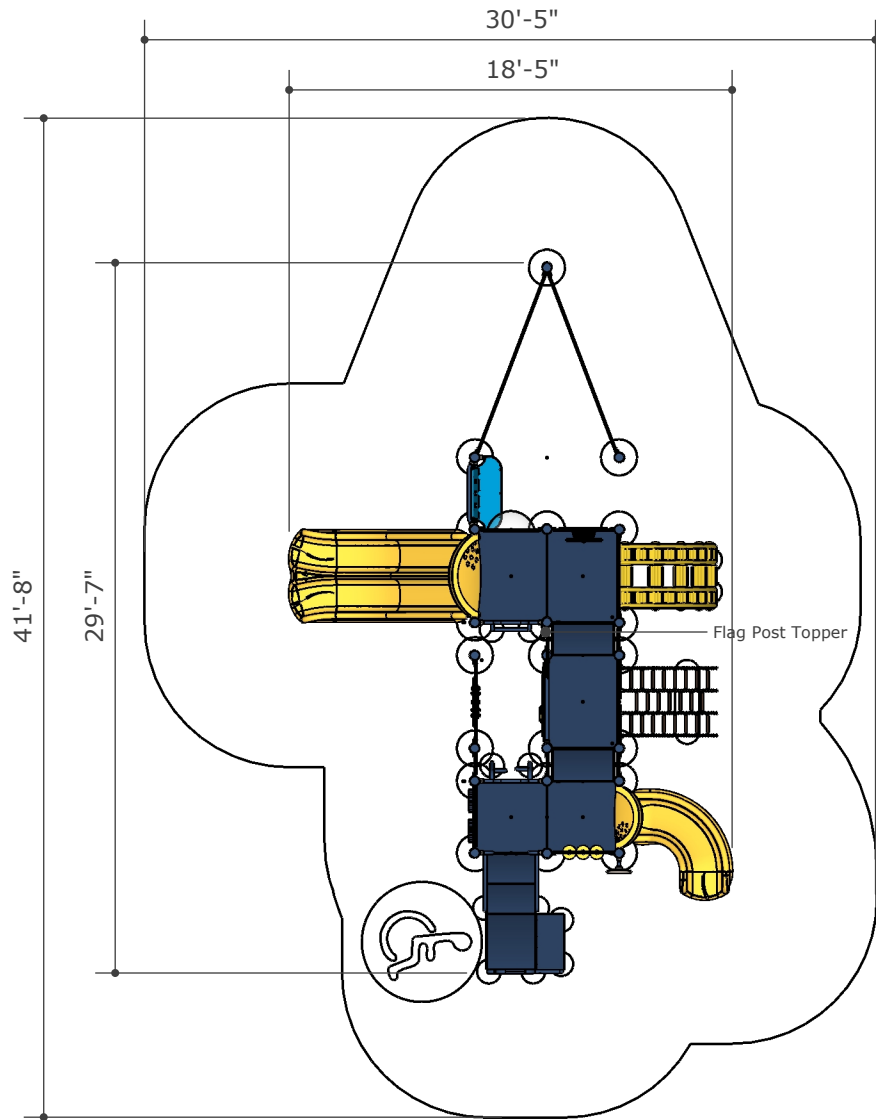

Partner

Superior[®]
RECREATIONAL PRODUCTS
A PLAYCORE Company

<https://srpplayground.com/>



srpplayground.com
866-795-7545