

Transfer

**Structure: IP23139**  
**Series: Contained / Age: 2-12 y/o**

**Preliminary Concept Design**

*Conceptual Renderings Only. Subject to change without notice at SRP's Discretion*

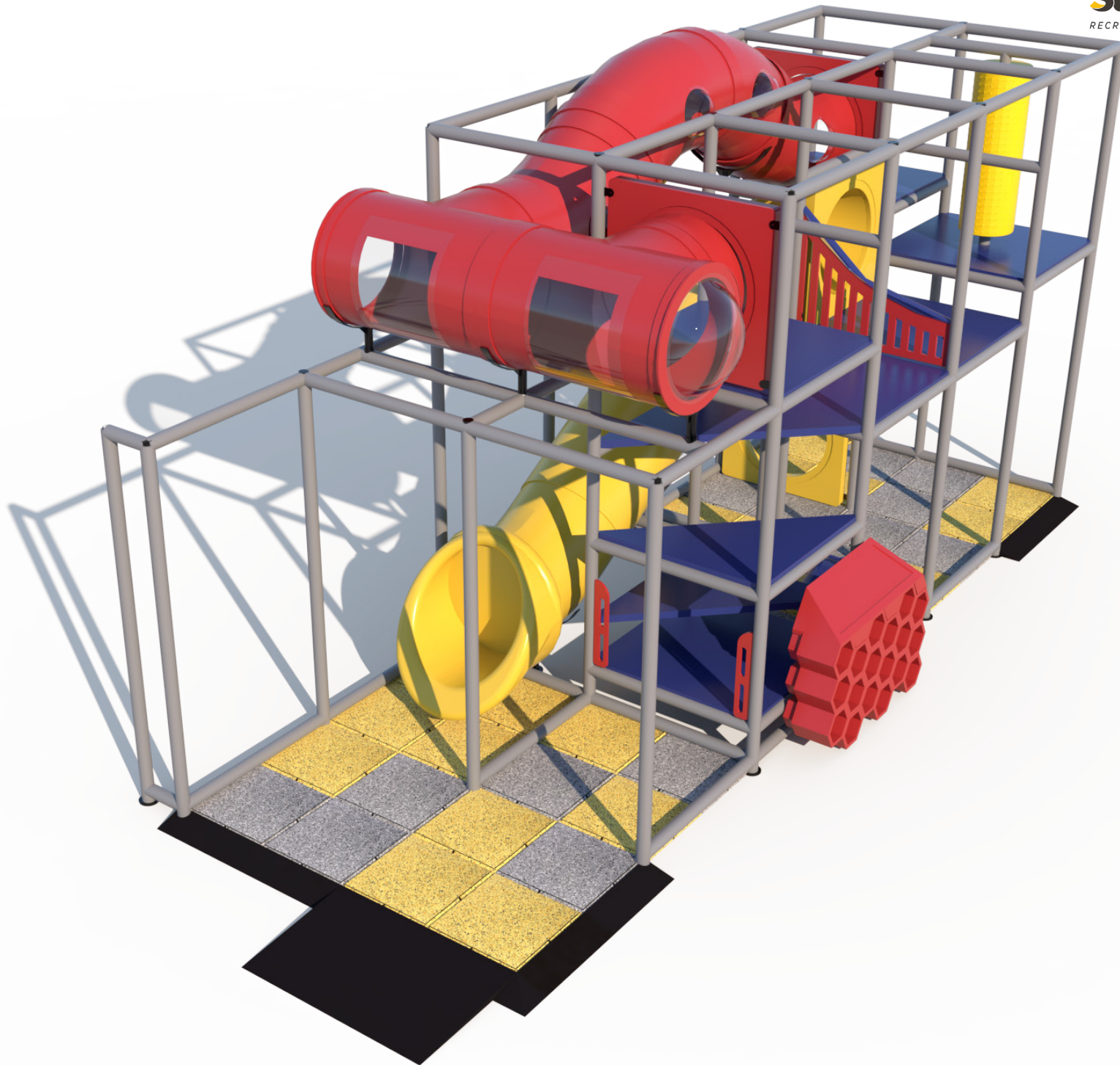

Transfer

**Structure: IP23139**  
**Series: Contained / Age: 2-12 y/o**

**Preliminary Concept Design**

*Conceptual Renderings Only. Subject to change without notice at SRP's Discretion*

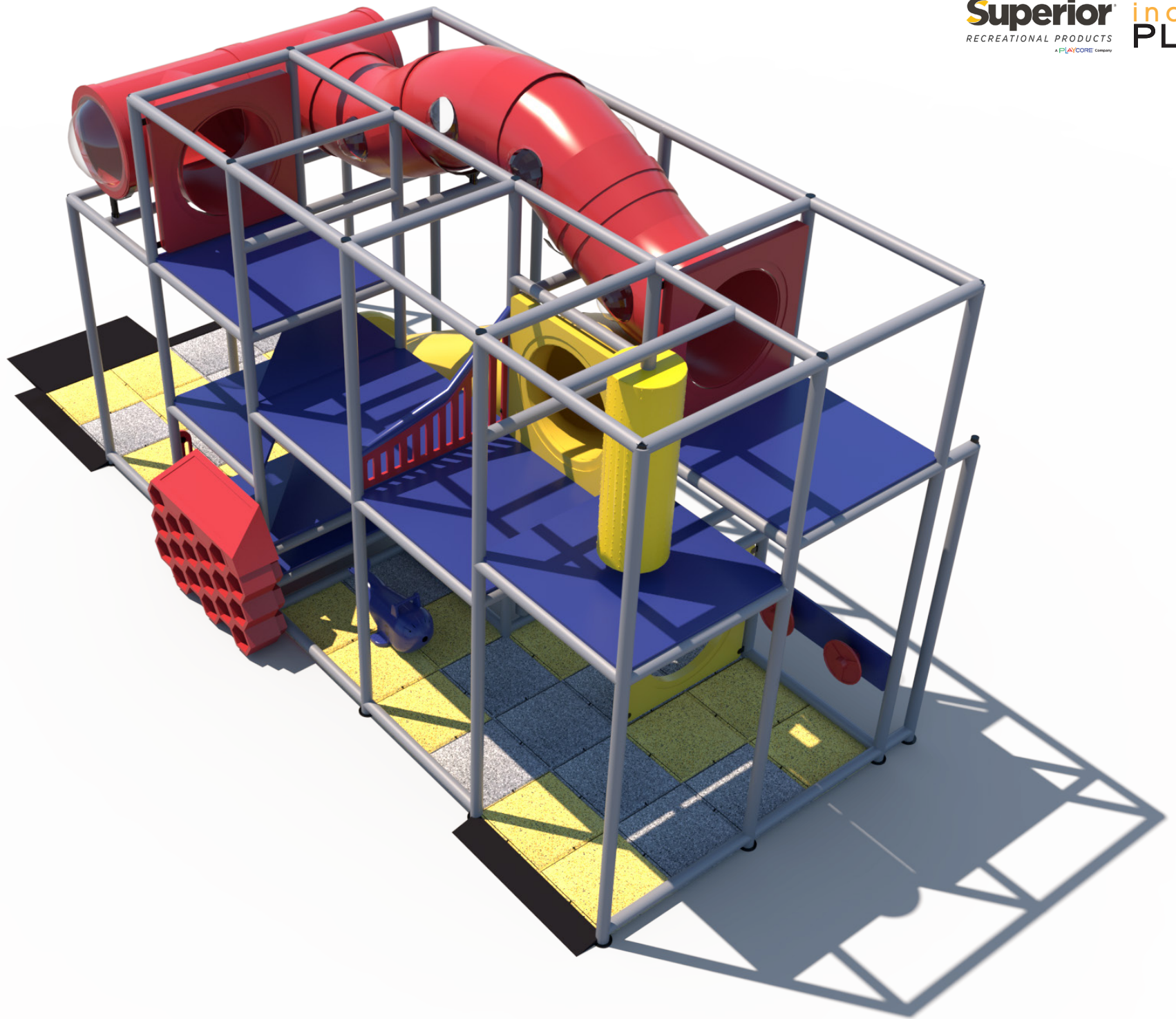

**Structure: IP23139**  
**Series: Contained / Age: 2-12 y/o**

**Preliminary Concept Design**

*Conceptual Renderings Only. Subject to change without notice at SRP's Discretion*

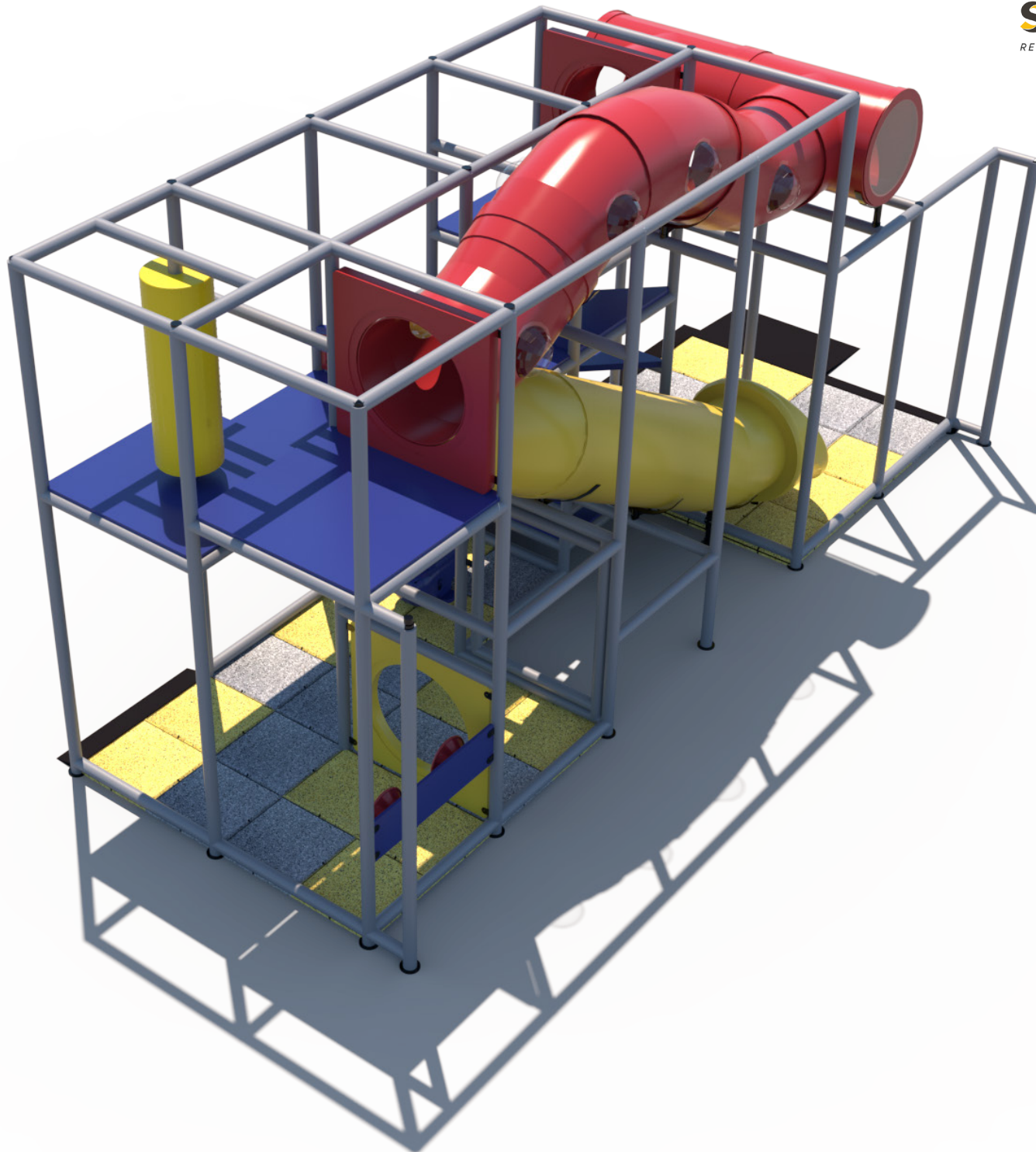

Transfer

**Structure: IP23139**  
Series: Contained / Age: 2-12 y/o

**Preliminary Concept Design**

*Conceptual Renderings Only. Subject to change without notice at SRP's Discretion*

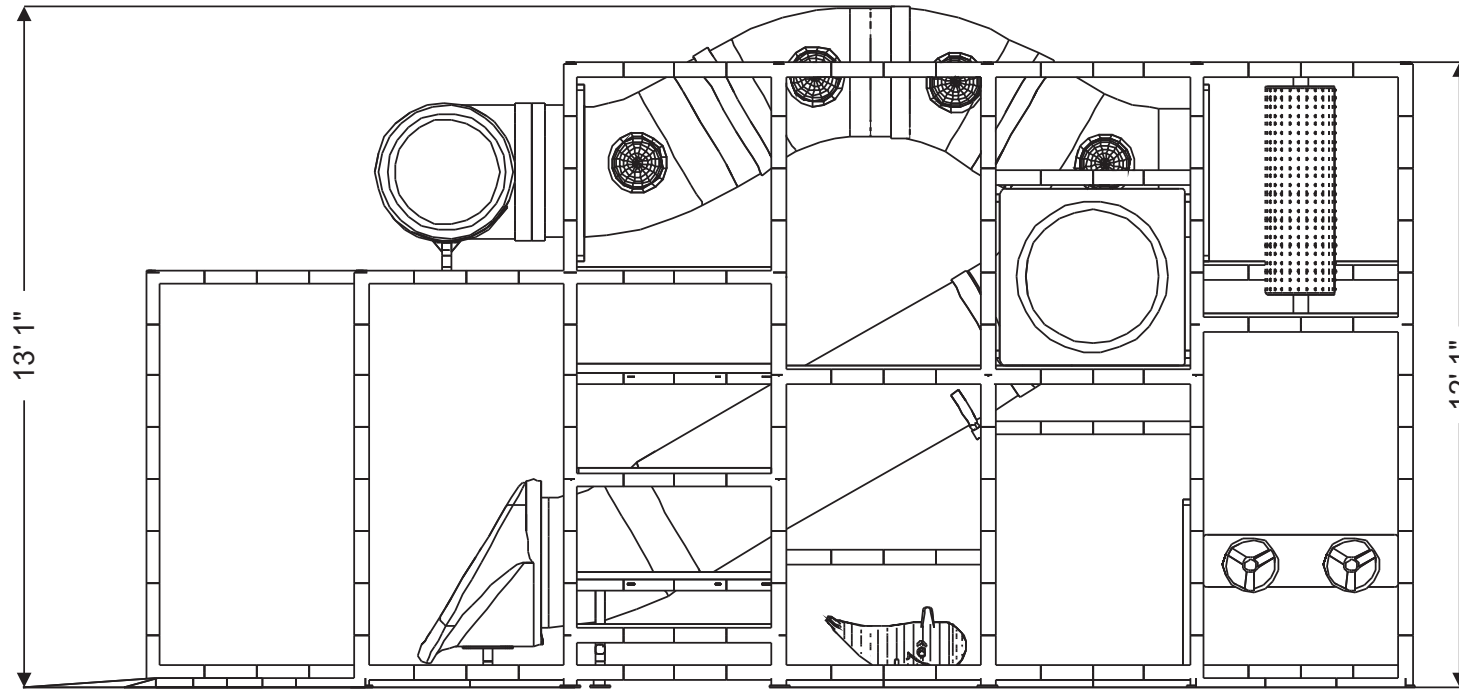
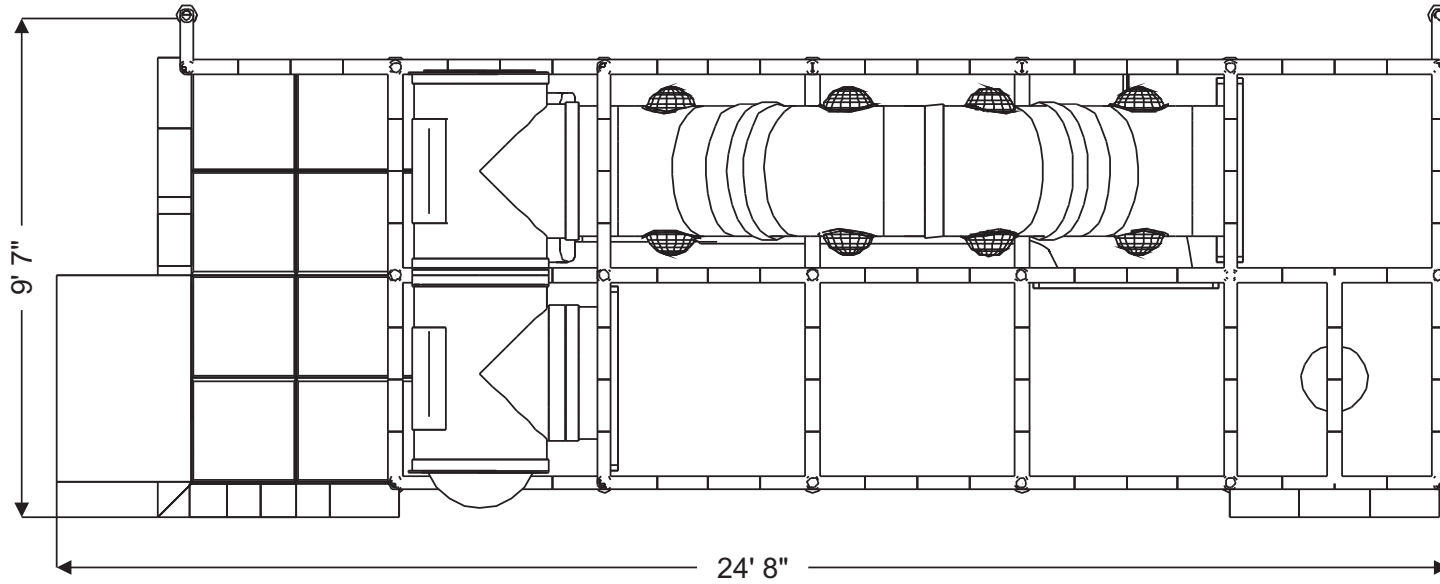

**Structure Capacity: 25**

**Structure: IP23139**  
**Series: Contained / Age: 2-12 y/o**

**Preliminary Concept Design**

*Conceptual Renderings Only. Subject to change without notice at SRP's Discretion*



**Transfer**

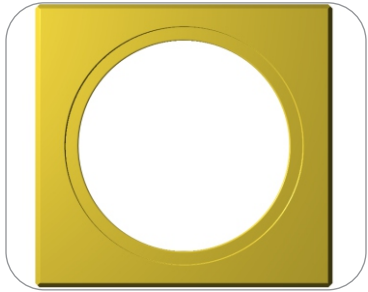

Crawl Through Panel  
*Toddler Activity*



Wave Run

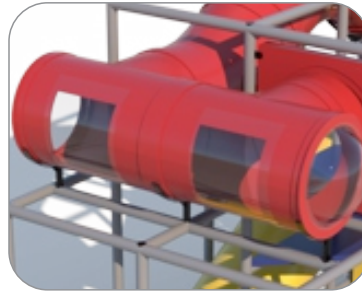

8' T-Tube Crawl Tunnel  
with Lookout Windows



12' Wave Crawl Tunnel  
with Bubble Windows



6' 8" Enclosed  
Hook Tube Slide

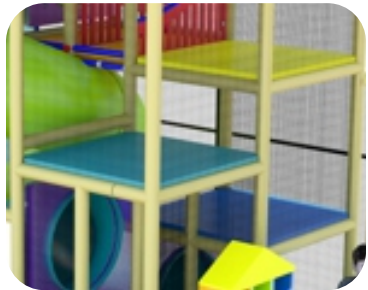

6 Level  
Deck Climb

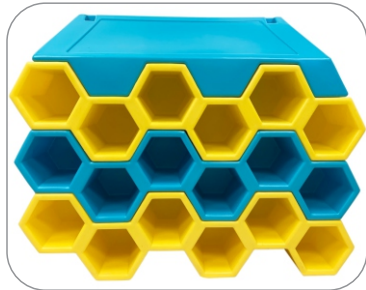

Sneaker Keeper



(2) Steering Wheel



Sit 'n Play  
Whale Riding Animal  
*Toddler Activity*



Squeeze Play



Transfer

**Roto Plastic:**

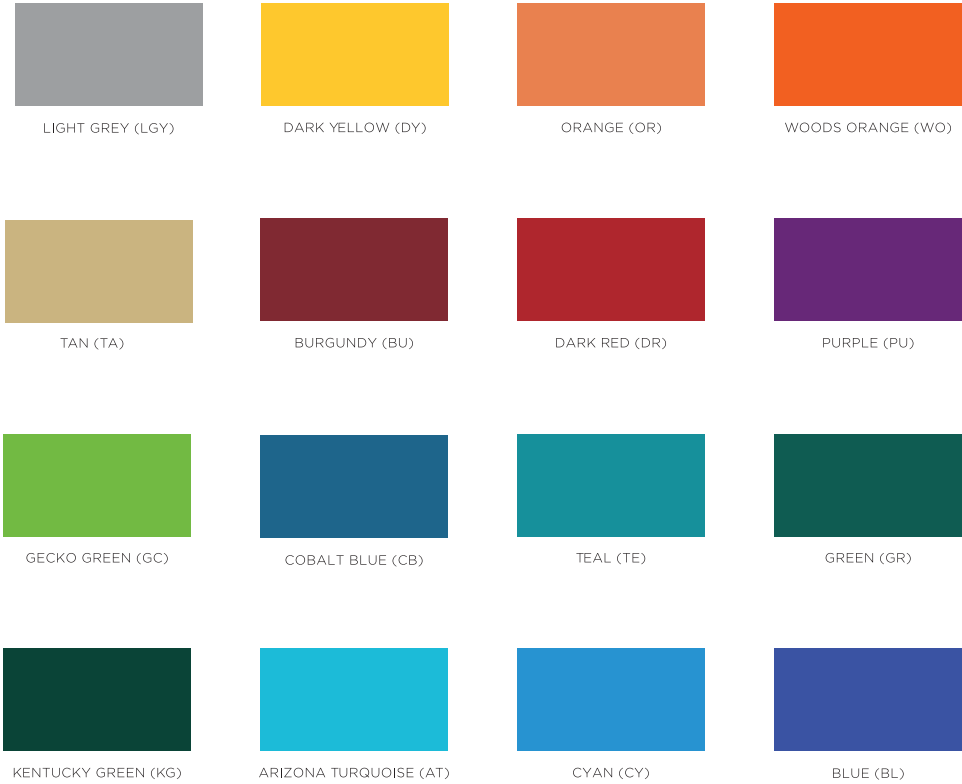

**HDPE:**



Black, Red, Yellow, Blue, Green, & Tan

**Metals:**



Green, Blue, Yellow, Red, Tan, Black, Silver & White

**PVC Mesh:**

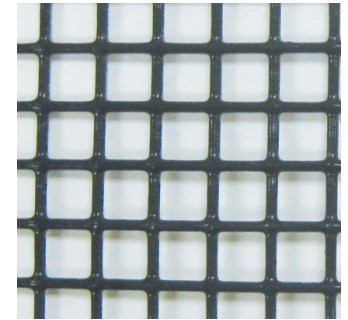

Black

**Post Foam:**



Black, Gray, Blue, Purple, Green, Tan, Red, & Yellow



## BUFFING TOP

Pigmented using organic powder color coating methods that will not delaminate over time.  
Sealed with specially formulated polymer agent that bonds pigments into the rubber.

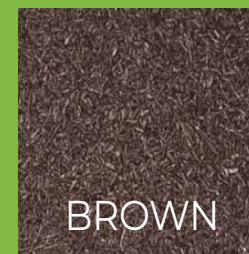



# EPDM TOP

EPDM granules are used to create options from bright solids to special blends for specific color themes. Mixtures includes a vibrant 90% EPDM/10% black mesh for standout solids, a 50/50 mix with black mesh, and mixtures with up to 3 EPDM colors. Ask your rep about specific blends to cover your space needs.

## STANDARD COLORS



BEIGE



BLUE



GREEN



RED

## PREMIUM COLORS\*



BRIGHT BLUE



DARK BLUE



DARK GREEN



PINK



LILAC



BRIGHT RED



BRIGHT GREEN



BRIGHT YELLOW



YELLOW



BRIGHT ORANGE



BEIGE BROWN



BROWN



WHITE



EGGSHELL



GRAY



MIDDLE GRAY

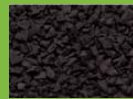

DARK GRAY



GEZOFLEX  
EPDM FOR SYNTHETIC FLOORING

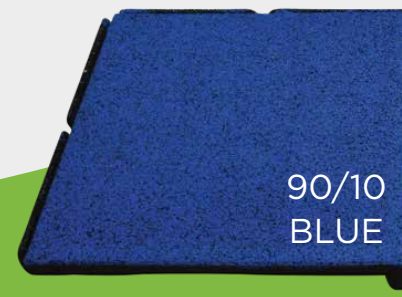

90/10  
BLUE

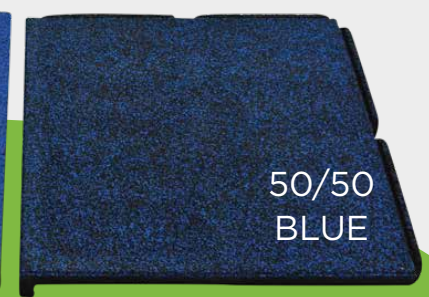

50/50  
BLUE

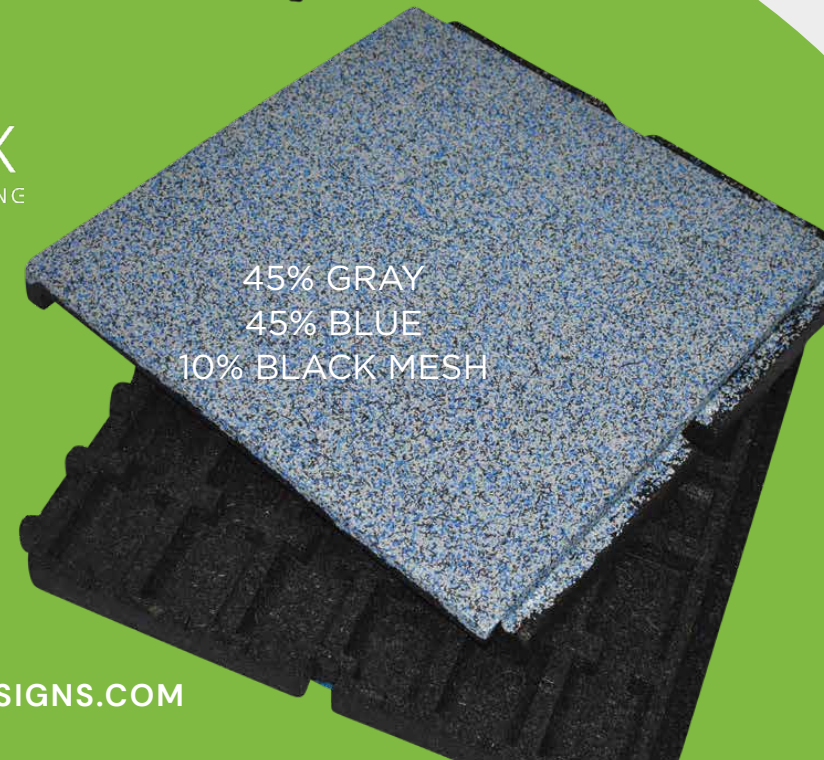

45% GRAY  
45% BLUE  
10% BLACK MESH

*\*Premium colors subject to upcharges*



706-383-7528



WWW.RUBBERDESIGNS.COM