

Transfer

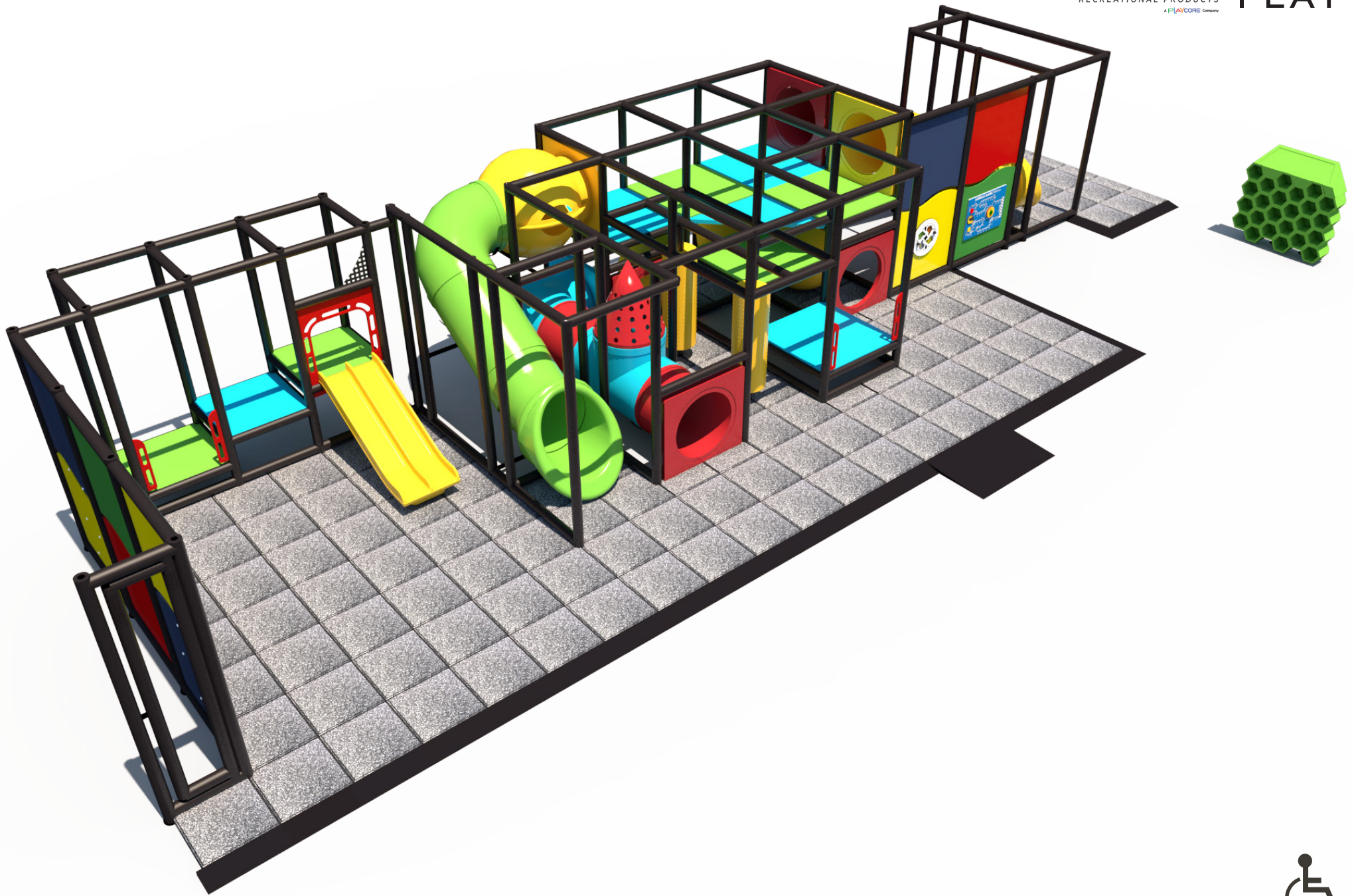

Structure: IP23152
Series: Contained / Age: 2-12 y/o

Preliminary Concept Design

Conceptual Renderings Only. Subject to change without notice at SRP's Discretion



Transfer

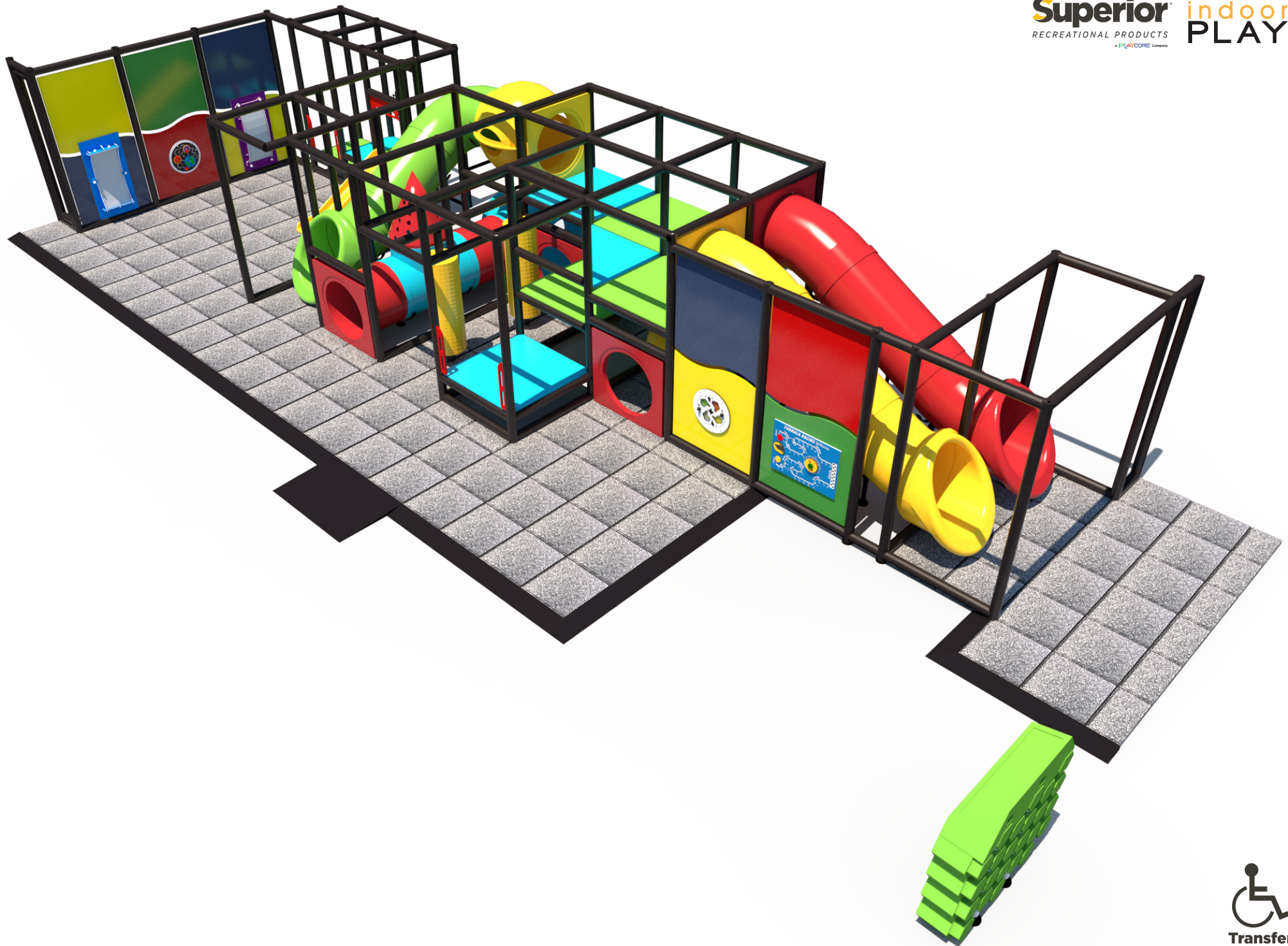

Structure: IP23152
Series: Contained / Age: 2-12 y/o

Preliminary Concept Design

Conceptual Renderings Only. Subject to change without notice at SRP's Discretion

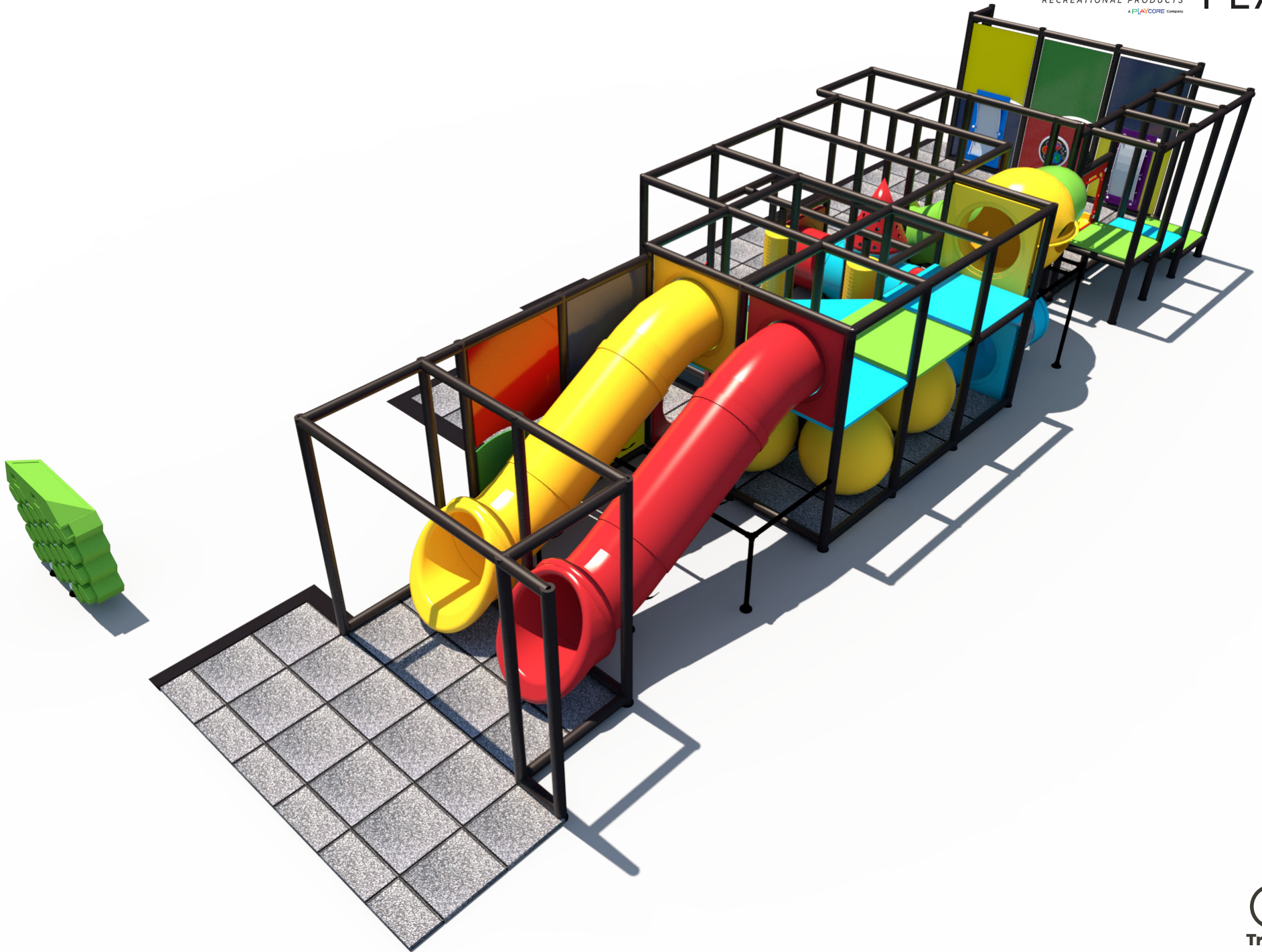

Transfer

Structure: IP23152
Series: Contained / Age: 2-12 y/o

Preliminary Concept Design

Conceptual Renderings Only. Subject to change without notice at SRP's Discretion

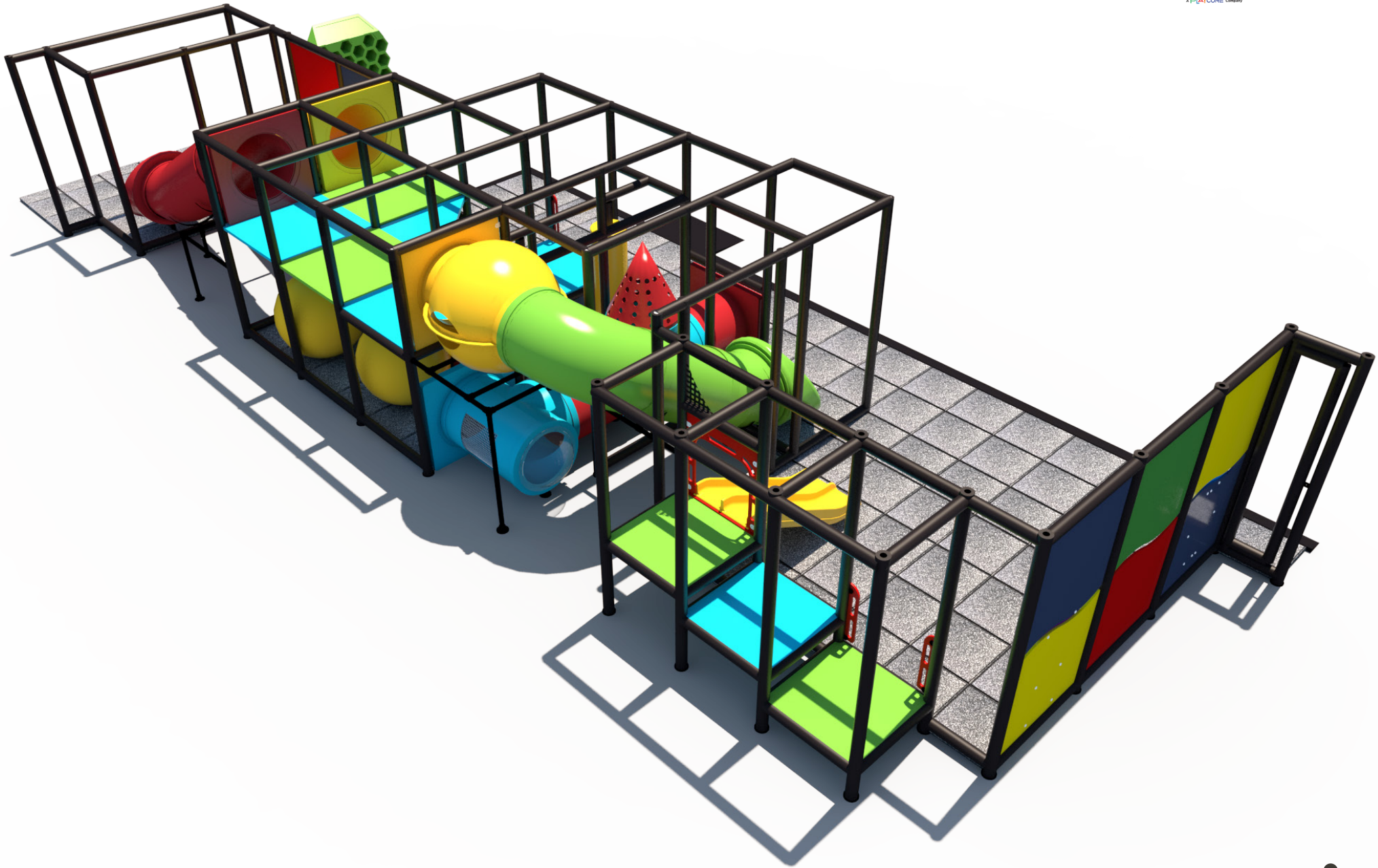

Transfer

Structure: IP23152
Series: Contained / Age: 2-12 y/o

Preliminary Concept Design

Conceptual Renderings Only. Subject to change without notice at SRP's Discretion

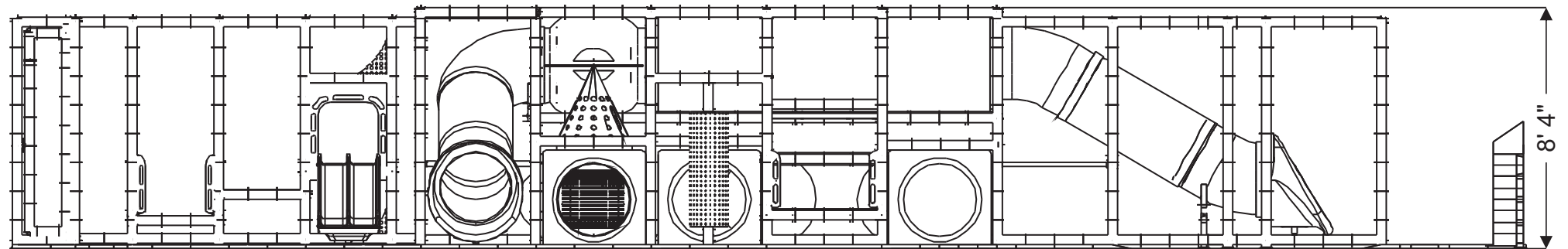
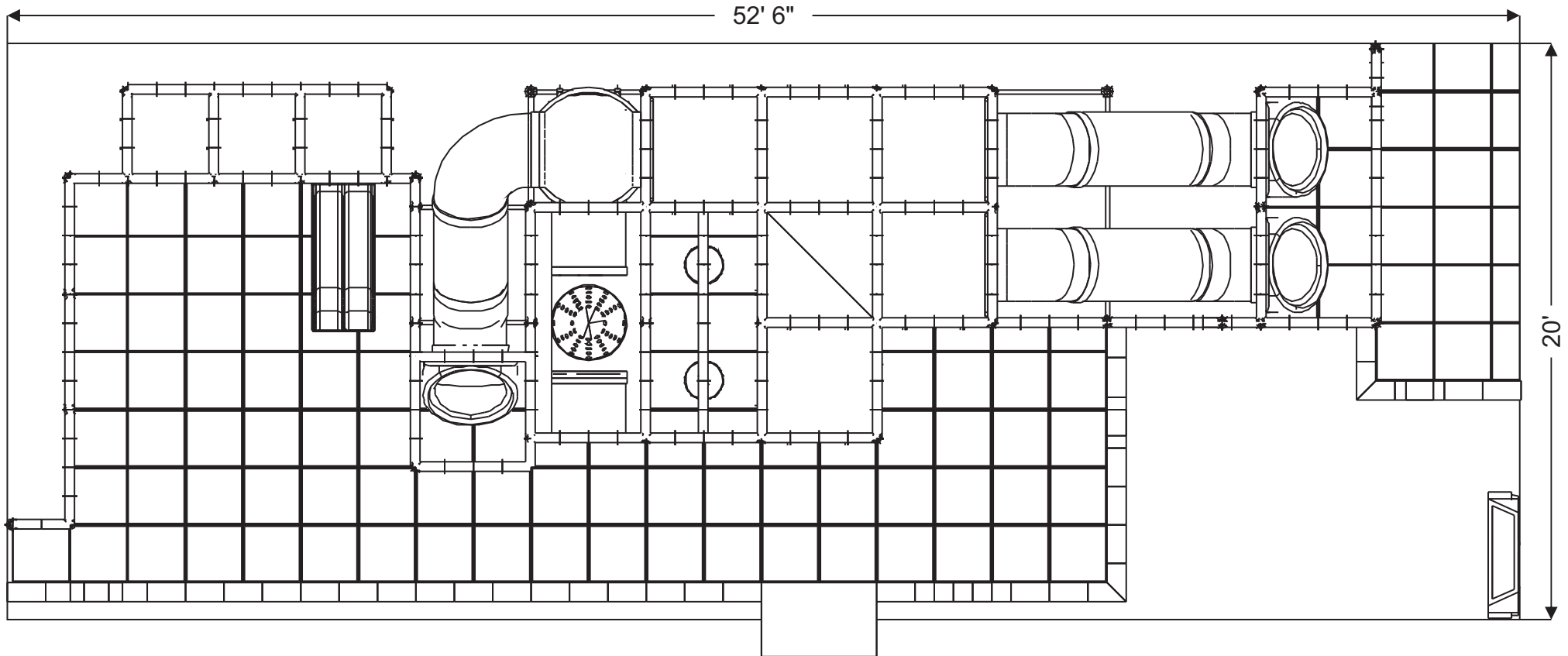

Structure Capacity: 35



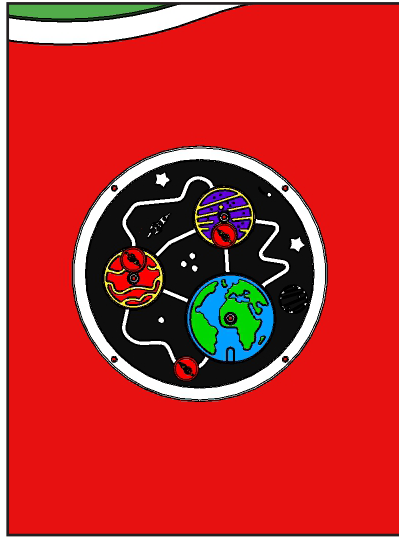

Solar Explorer

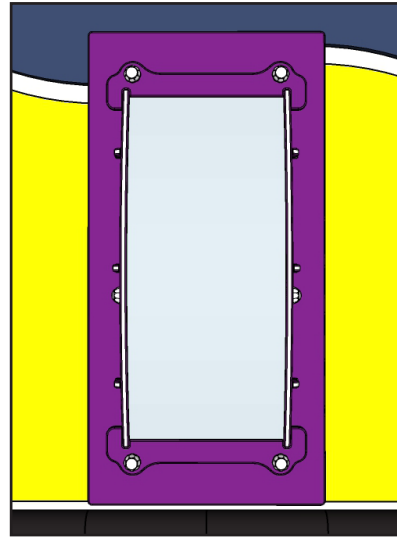

Convex Mirror

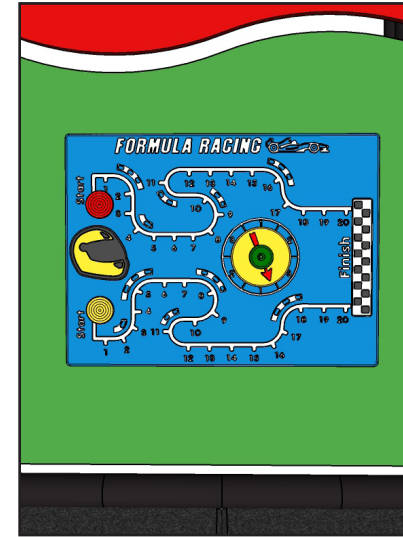

Formula Racing

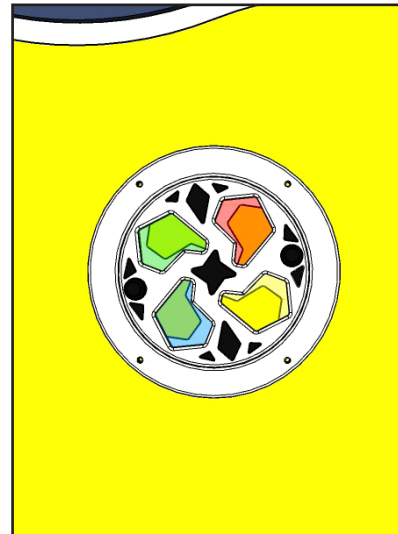

Color Wheel
Kaleidoscope

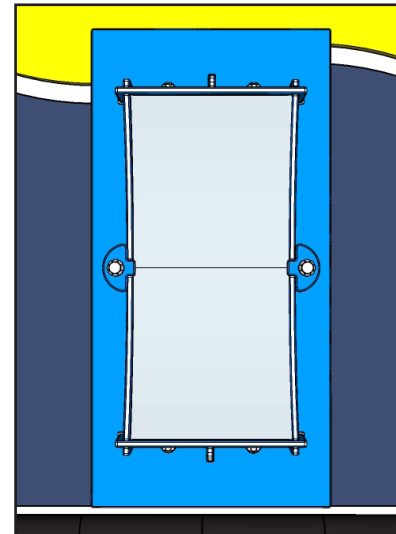

Concave Mirror



Transfer

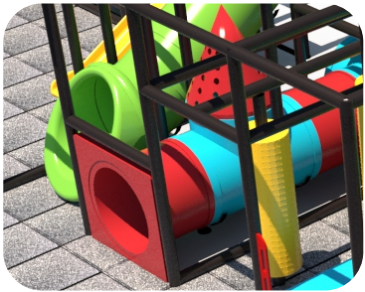

11' Crawl Tunnel with
Cone Lookout

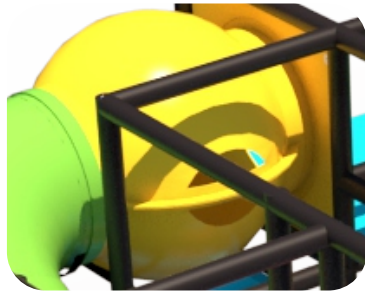

Sphere Junction
with Lookout Windows



Tot Triple Rail Slide



3 & 4 Level
Deck Climbs

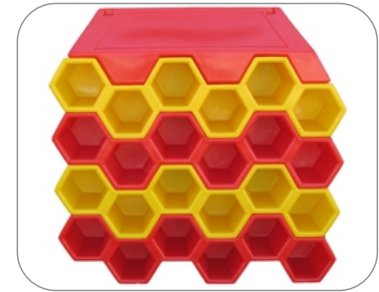

Sneaker Keeper

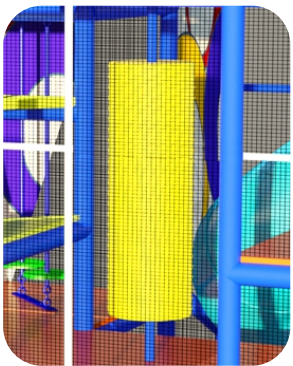

(2) Squeeze Plays



T-Tube Junction
with Lookout Windows



5' 2" Enclosed
Hook Tube Slides



(2) 5' 2" Enclosed
Straight Tube Slides

Image Not Available

Large Ball
Obstacle Alley



Transfer

Roto Plastic:

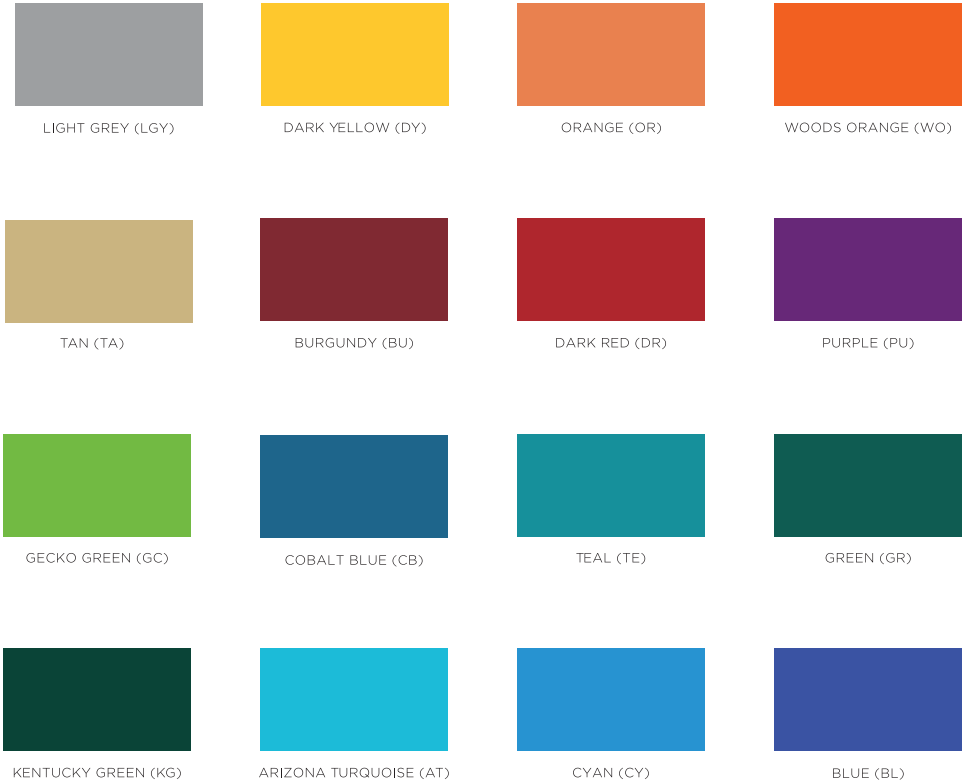

HDPE:

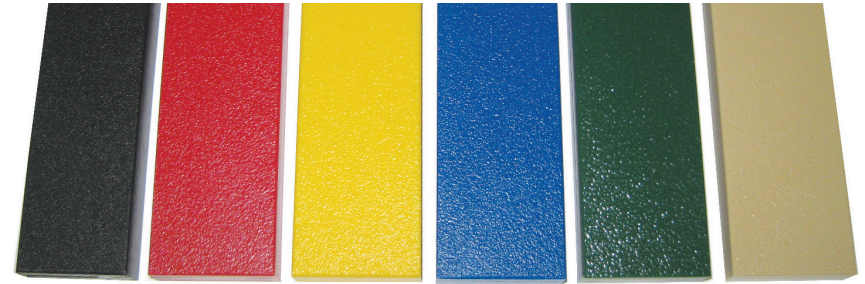

Black, Red, Yellow, Blue, Green, & Tan

Metals:



Green, Blue, Yellow, Red, Tan, Black, Silver & White

PVC Mesh:

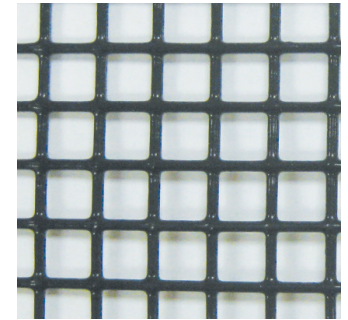

Black

Post Foam:



Black, Gray, Blue, Purple, Green, Tan, Red, & Yellow



BUFFING TOP

Pigmented using organic powder color coating methods that will not delaminate over time.
Sealed with specially formulated polymer agent that bonds pigments into the rubber.

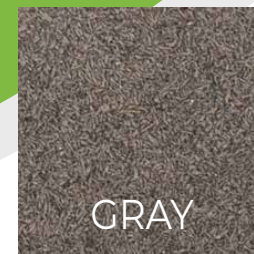
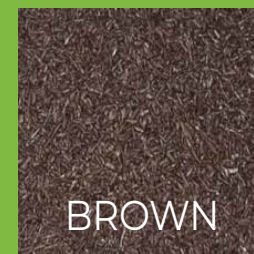

EPDM TOP

EPDM granules are used to create options from bright solids to special blends for specific color themes. Mixtures includes a vibrant 90% EPDM/10% black mesh for standout solids, a 50/50 mix with black mesh, and mixtures with up to 3 EPDM colors. Ask your rep about specific blends to cover your space needs.

STANDARD COLORS



BEIGE



BLUE



GREEN



RED

PREMIUM COLORS*



BRIGHT BLUE



DARK BLUE



DARK GREEN



PINK



LILAC



BRIGHT RED



BRIGHT GREEN



BRIGHT YELLOW



YELLOW



BRIGHT ORANGE



BEIGE BROWN



BROWN



WHITE



EGGSHELL



GRAY



MIDDLE GRAY

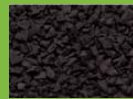

DARK GRAY



GEZOFLEX
EPDM FOR SYNTHETIC FLOORING

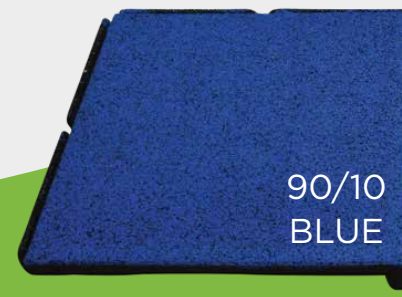

90/10
BLUE

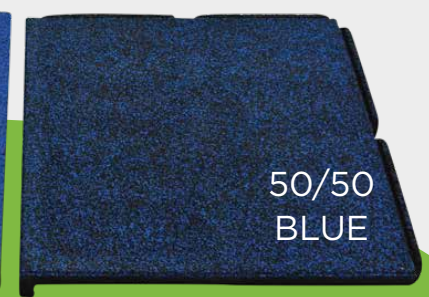

50/50
BLUE

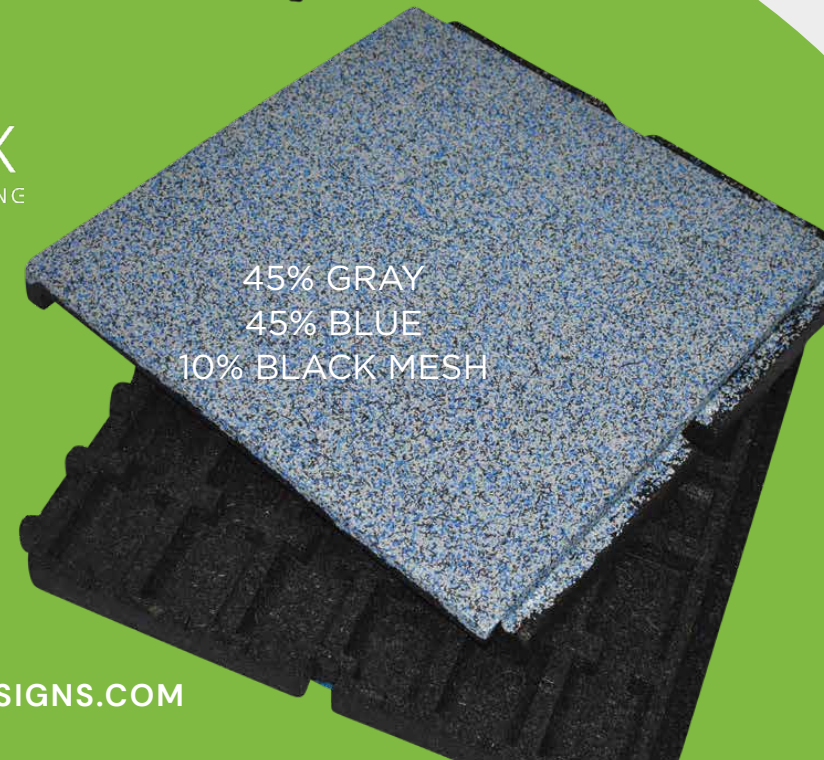

45% GRAY
45% BLUE
10% BLACK MESH

**Premium colors subject to upcharges*



706-383-7528



WWW.RUBBERDESIGNS.COM