

TOP VIEW

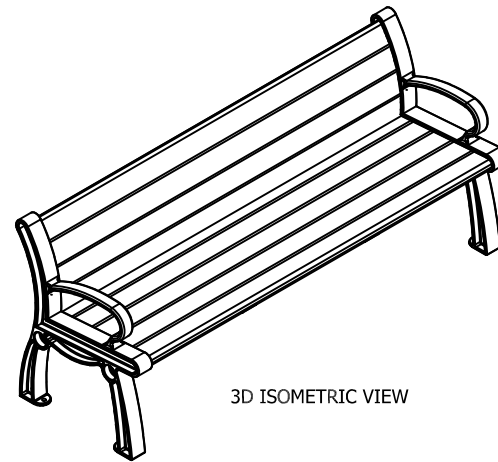

3D ISOMETRIC VIEW

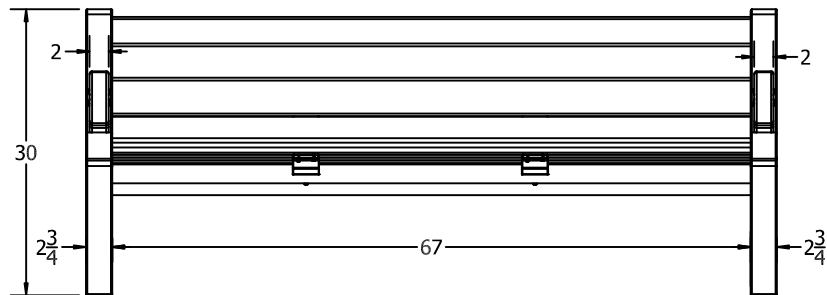

FRONT VIEW

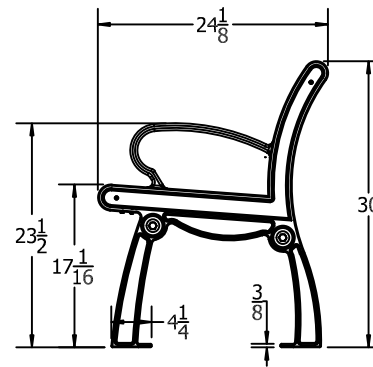

SIDE VIEW



INSERT COLOR CODE IN PRODUCT NUMBER  
 CEDAR= CED, GRAY= GRA, GREEN= GRE, BLACK= BLA,  
 BLUE= BLU, BROWN=BRO, RED= RED, WHITE=WHI

EXAMPLE: CEDAR HERITAGE 6 FT. BENCH W/  
 BLACK FRAME = PB 6CEDBFHER

# 6 Ft. Heritage Bench Spec Sheet

©COPYRIGHT 2013-2033

THIS COPYRIGHTED MATERIAL IS THE PROPERTY OF FROG FURNISHINGS AND SHALL NOT BE REPRODUCED, PUBLISHED OR DISCLOSED TO OTHERS WITHOUT AUTHORIZATION AND CANNOT BE USED IN ANY WAY AGAINST OR DETRIMENTAL TO JAYHAWK PLASTICS INC. OLATHE, KANSAS USA

Frog Furnishings  
 15750 S. Keeler Terrace  
 Olathe, KS 66062  
[www.frogfurnishings.com](http://www.frogfurnishings.com)

NOT TO SCALE  
 Date: 02/2019

