



**Structure: R3FX-30159**  
**Theme: Cottages**

**Preliminary Concept Design**  
**Designer: N.Guice**      **Date: 11/30/2020**

*Conceptual Renderings Only. Subject to change without notice at SRP's Discretion*



**Structure: R3FX-30159**  
Age: 2 - 12 / Series: Recycled / Theme: Cottage

**Preliminary Concept Design**

*Conceptual Renderings Only. Subject to change without notice at SRP's Discretion*





**Structure: R3FX-30159**  
Age: 2 - 12 / Series: Recycled / Theme: Cottage

**Preliminary Concept Design**

*Conceptual Renderings Only. Subject to change without notice at SRP's Discretion*

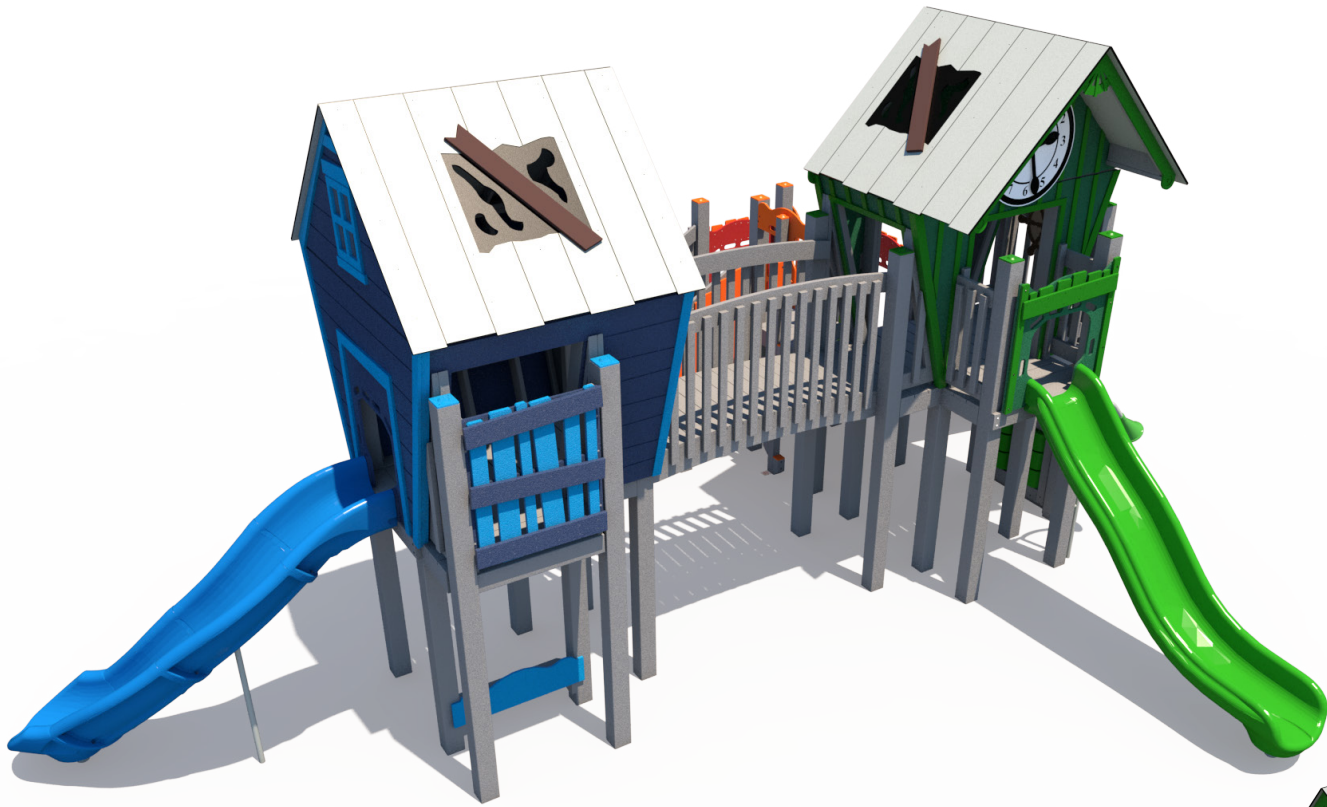

**Structure: R3FX-30159**  
Age: 2 - 12 / Series: Recycled / Theme: Cottage

**Preliminary Concept Design**

*Conceptual Renderings Only. Subject to change without notice at SRP's Discretion*

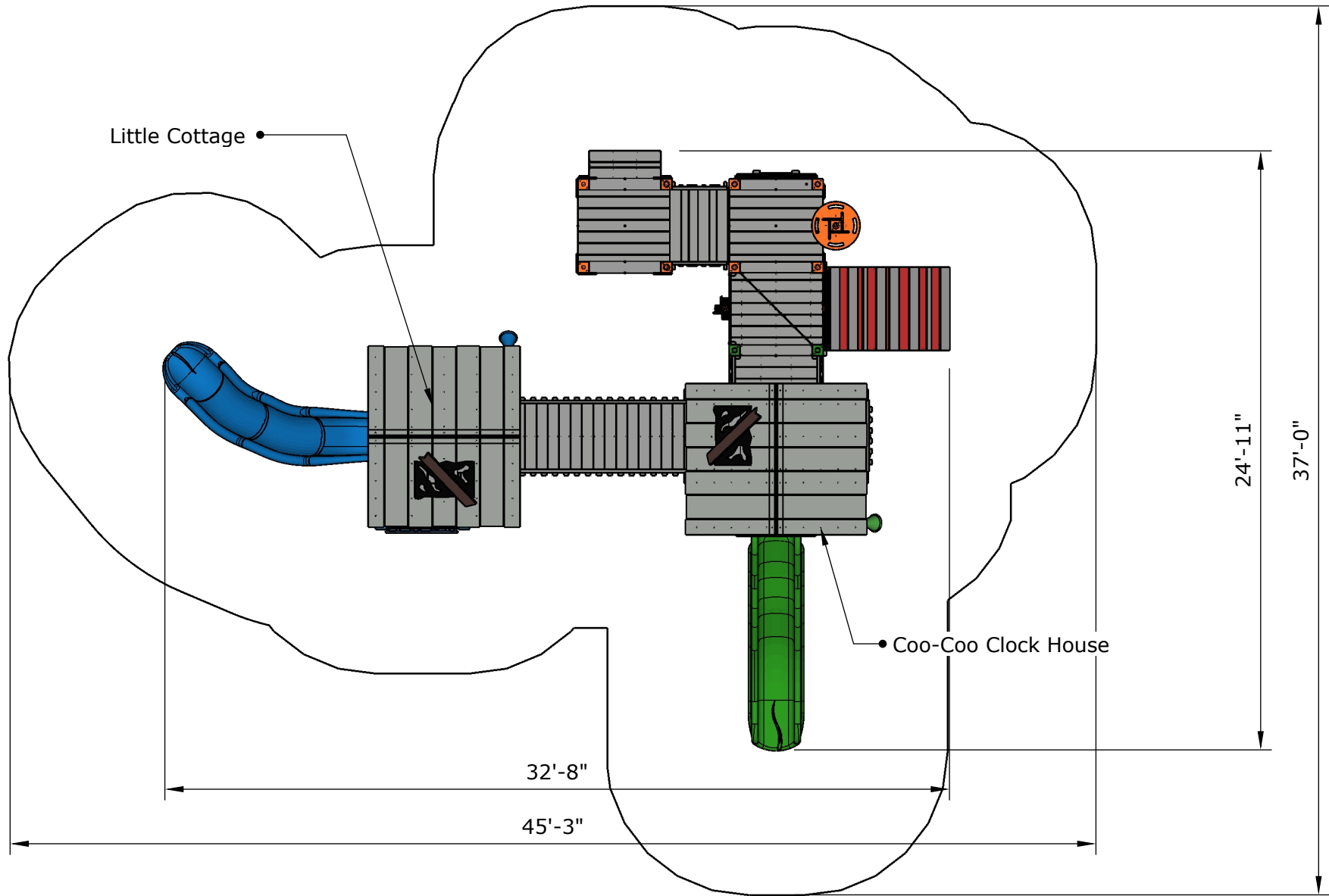

Ages	Capacity	Use Zone	Fall Height	Actual Size	Timber Count	Elevated Activities
2-12	80	46'x37'	72"	33'x25'	36	7

Scale: 1" = 6'



	Ground Level Accessible Play Activities	Ground Level Accessible Activity Types
Required	2	2
Provided	2	2



**Structure: R3FX-30159**  
 Age: 2 - 12 / Series: Recycled / Theme: Cottage

**Preliminary Concept Design**

*Conceptual Renderings Only. Subject to change without notice at SRP's Discretion*

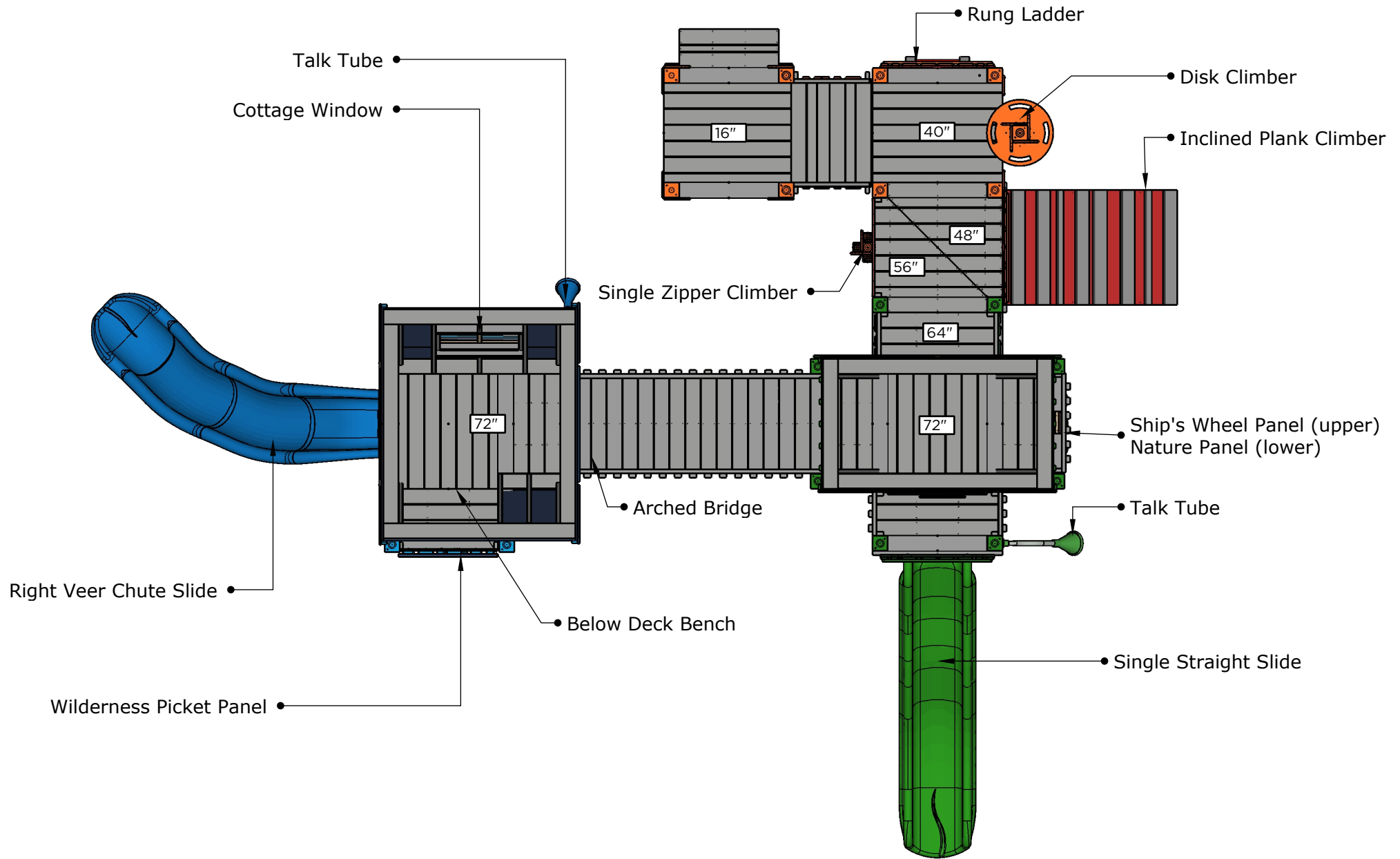

Ages	Capacity	Use Zone	Fall Height	Actual Size	Timber Count	Elevated Activities
2-12	80	46'x37'	72"	33'x25'	36	7

Scale: 1" = 4'



	Ground Level Accessible Play Activities	Ground Level Accessible Activity Types
Required	2	2
Provided	2	2

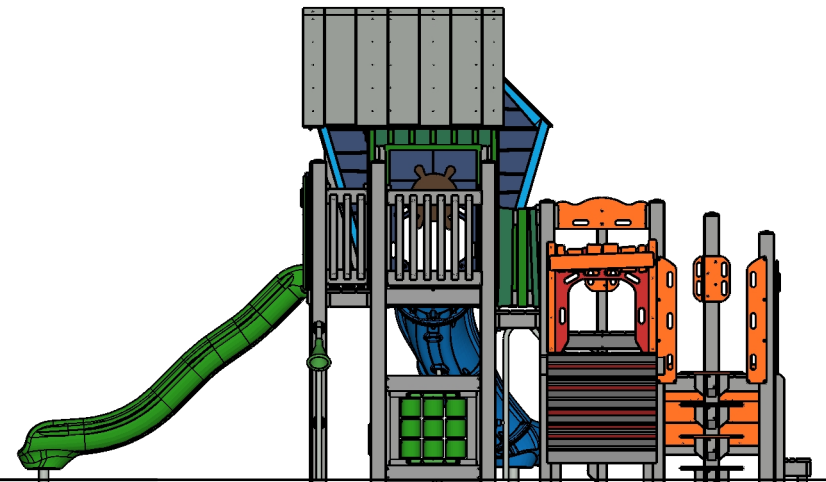
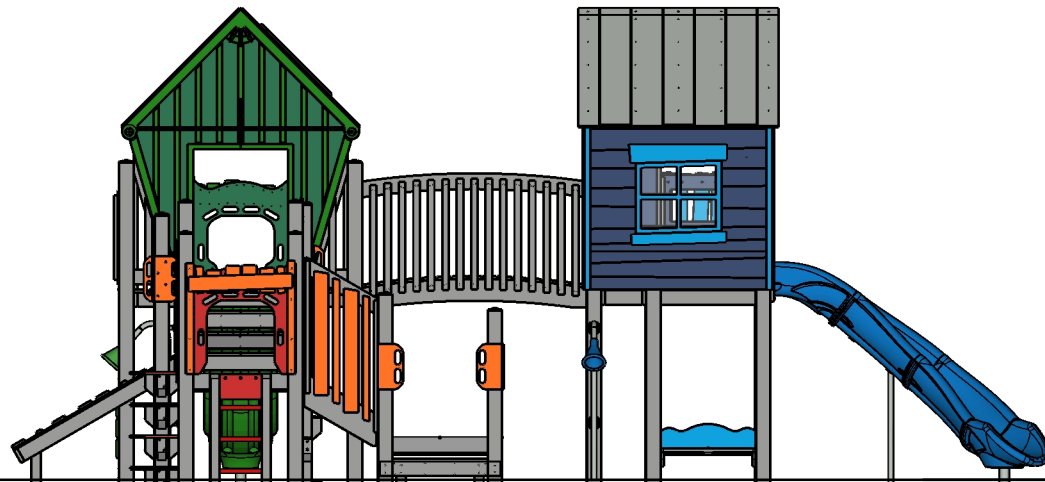
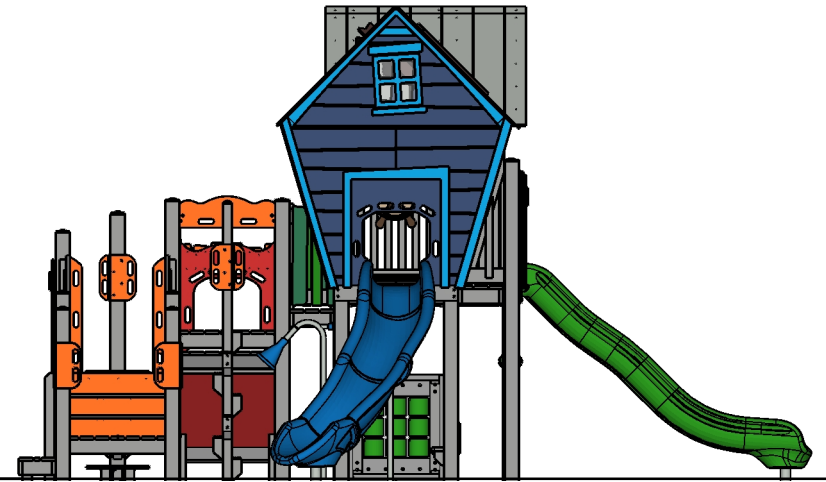
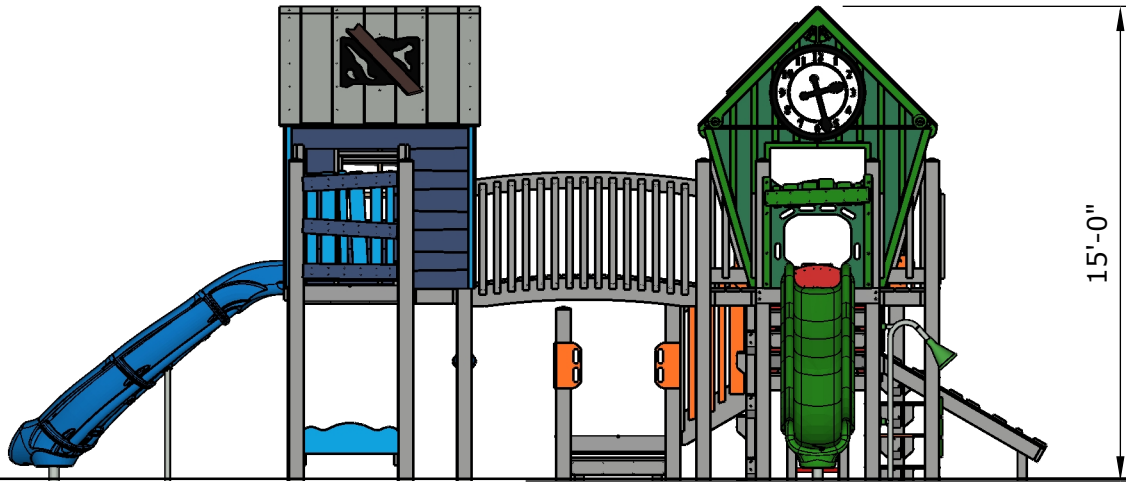

Ages	Capacity	Use Zone	Fall Height	Actual Size	Timber Count	Elevated Activities
2-12	80	46'x37'	72"	33'x25'	36	7

Scale: 1" = 6'



**Structure: R3FX-30159**  
 Age: 2 - 12 / Series: Recycled / Theme: Cottage

**Preliminary Concept Design**

*Conceptual Renderings Only. Subject to change without notice at SRP's Discretion*



SRP **FX**

 **SUPERIOR**  
RECREATIONAL PRODUCTS

A **PLAYCORE** Company

[superiorecreation.com](http://superiorecreation.com) • [sales@siibrands.com](mailto:sales@siibrands.com) • 800.327.8774